



# DESIRING EXPERIENCES OVER THINGS

has become a modern-day mantra. This season we take this mantra to heart and highlight the reasons why people travel: for boundless joy, a feeling of freedom, new barefoot luxury and even higher learning. As you browse through this catalogue of innovations, we hope you'll find inspiration from the currents of social change that drive us.

When we dream of far-away places, the background of a perfect holiday is always a quality of blue we're calling Majestic. This versatile new color option, which is as intense as the sea and as clear as the wide-open sky, will be available in a variety of cuts and shapes for boundless creative possibilities. Majestic Blue's deep hues are the perfect complement to three Crystal Shiny Lacquer<sup>Pro</sup> Effects – Crystal Buttercup, Crystal Lime & Crystal Lilac – for elegant styles, bold streamlined looks and expressive designs.

In addition to closely following trends, it is you – our clients – who inspire us to push our boundaries and to offer the most innovative crystal products and services. This season, we are pleased to present new shapes and cuts such as the Classic Cut Pendant, Geometric Flat Backs, Teardrop Fancy Stone, Mini Size Flat Backs and even the adaptable Fine Rock Tubes, which merge the appeal of sparkling crystal with metal elements and streamlined shapes.

We hope to fuel your imagination!

  
Markus Langer-Swarovski

## INNOVATION HIGHLIGHTS

- 2 NEW COLOR MAJESTIC BLUE
- 4 NEW BEAD FINE ROCKS TUBE
- 5 NEW FLAT BACKS GEOMETRIC
- 6 NEW PENDANT CLASSIC CUT

## INSPIRATIONS

- 10 CULTURE
- 16 FREEDOM
- 22 ADVENTURE
- 30 LEISURE

## INNOVATIONS

- 40 CONTENTS

---

INNOVATION HIGHLIGHTS

SPRING / SUMMER

19

---

CLOSE YOUR EYES TIGHT.  
THE LASTING IMAGE OF YOUR MIND'S EYE  
IS LIKE A PHOTO NEGATIVE OF THE  
IDEA YOU CAN'T GET OUT OF YOUR HEAD.  
THIS IS THE STUFF OF IMAGINATION.

In the pages that follow, you'll find yet undiscovered elements sparkling at the heart of a lavish new design. The right cut is essential, as is the color; it has to be perfect. It's an indescribable hue with an almost ethereal quality and it's only from Swarovski.

---

NEW COLOR

## MAJESTIC BLUE

Deep and evocative, like an homage to cobalt skies and sapphire seas, Swarovski presents Majestic Blue: the color of lasting memories. Pure and with a deeper hue and more intense sparkle than any previous shade of blue, this color is ideal for costume jewelry, apparel, and accessories. Now available throughout the entire product range, the possibilities with this luxurious crystal shade are as wide open as the skies.

Check colors and sizes on page 43.



---

NEW BEAD

## FINE ROCKS TUBE

Like a chandelier suspended from a beautiful ceiling, this chute of crystals is the perfect eye catching element for jewelry or accessories. The Fine Rocks Tube is the culmination of fashion-forward thinking for the creation of new hybrid beads for highly individualistic designs. Featuring a pavé look with highly refined surface brilliance with double-pointed chatons, these special elements are available in a variety of colors and effects. Application is easy: Sew on or use as a bead.

Check colors and sizes on page 61.







---

NEW FLAT BACKS

## GEOMETRIC

Choose your sequence and go: Geometric Flat Backs will jumpstart your design, energizing your pattern with form, energy, unity and balance. Infinitely combinable and featuring classic shapes with simple cuts, these versatile elements are perfect for crafting decorative designs or ornaments with repeatable patterns.

Check colors and sizes on pages 71 and 75.





---

NEW PENDANT

## CLASSIC CUT

Versatility never goes out of style. Neither does simplicity. Featuring a multilayer round cut ideal for creating the look of fine jewelry without the need for a setting, this classic gemstone-inspired crystal features 49 lustrous facets for brilliance that stands the test of time. Available in crystal and 11 other colors with 5 unique effects, this round pendant is ideally suited for jewelry and hand-sewn apparel and accessories.

Check colors and sizes on page 68.

## INSPIRATIONS

# WANDER LUST

Numbed and bored by today's technology driven world, we opt to refocus on the human element with its emotional, intellectual and spiritual demands. Craving connection, seeking authenticity and desiring the real, we travel the world – experiencing new cultures and exploring new regions in order to learn, grow and ultimately find happiness. Gap-year travels, adventure journeys, “snackable” holidays or luxury seafaring cruises confirm the new experience consumer for whom traveling is more than just going to a different place – it is about creating new meanings, and making the best of life.

This season we highlight new ways of fulfilment and satisfaction through travel experiences that transform us, bringing an element of joy to our lives.

WANDERLUST

## 10 – 15 CULTURE

Stemming from the increasing aspiration to add creativity and color into our lives, cities are becoming urban backgrounds for extreme art and sculptural installations. By releasing them from their traditional galleries, and connecting them directly with the environment and surroundings, art loses its exclusivity, and becomes inclusive. Becoming an active participant rather than a passive one, the new art tourist champions the designer within, surrounding themselves with the joy of artistic endeavors and reconnecting with their surroundings.

## 16 – 21 FREEDOM

As the desire to “get away from it all” gains increasing traction, the 70s surfer mantra of “take it easy”, has garnered a new cool cache for the next generation. Gen Z and Millennials are forging an upsurge in experience travel, as the desire to reconnect – with each other and nature – becomes ever more prevalent. Demanding sensorial experiences as a calming counterbalance to frenetic fast-paced living, this new-age traveler opts for a sense of total freedom in their travel plans.

## 22 – 29 ADVENTURE

A generational change has created a desire for experiences in the modern traveler's mindset. A nomadic journey away from the everyday unfolds as travel concepts – even for solo travelers – become more about the real, the rough and the ready. The focus is on nature, no crowds, and virtual silence with the re-engagement of a survival ethos holding new appeal for these “Wild Wanderers”. The fabulous freedom of a road trip, the emotional quest for solitude and the need for individual experience beckons.

## 30 – 35 LEISURE

The renewed focus on the privilege, indulgence and even expense of yachting is enticing a new league of affluent travelers. Becoming an emblem of barefoot luxury – it is lavish, full-frills tourism that lures with its prestige; for those who can afford it. The ability to pull up anchor and sail to the next secret destination, to customize and individualize the journey, highlights the sheer indulgence and appeal of this exclusive form of travel. Yet with the desire to escape, to relax, high on the priority list, the ultimate luxury remains the same – time!









IN A BLAZE OF RADIANCE, OUR  
INNER ARTIST WILL CAPTURE ATTENTION.

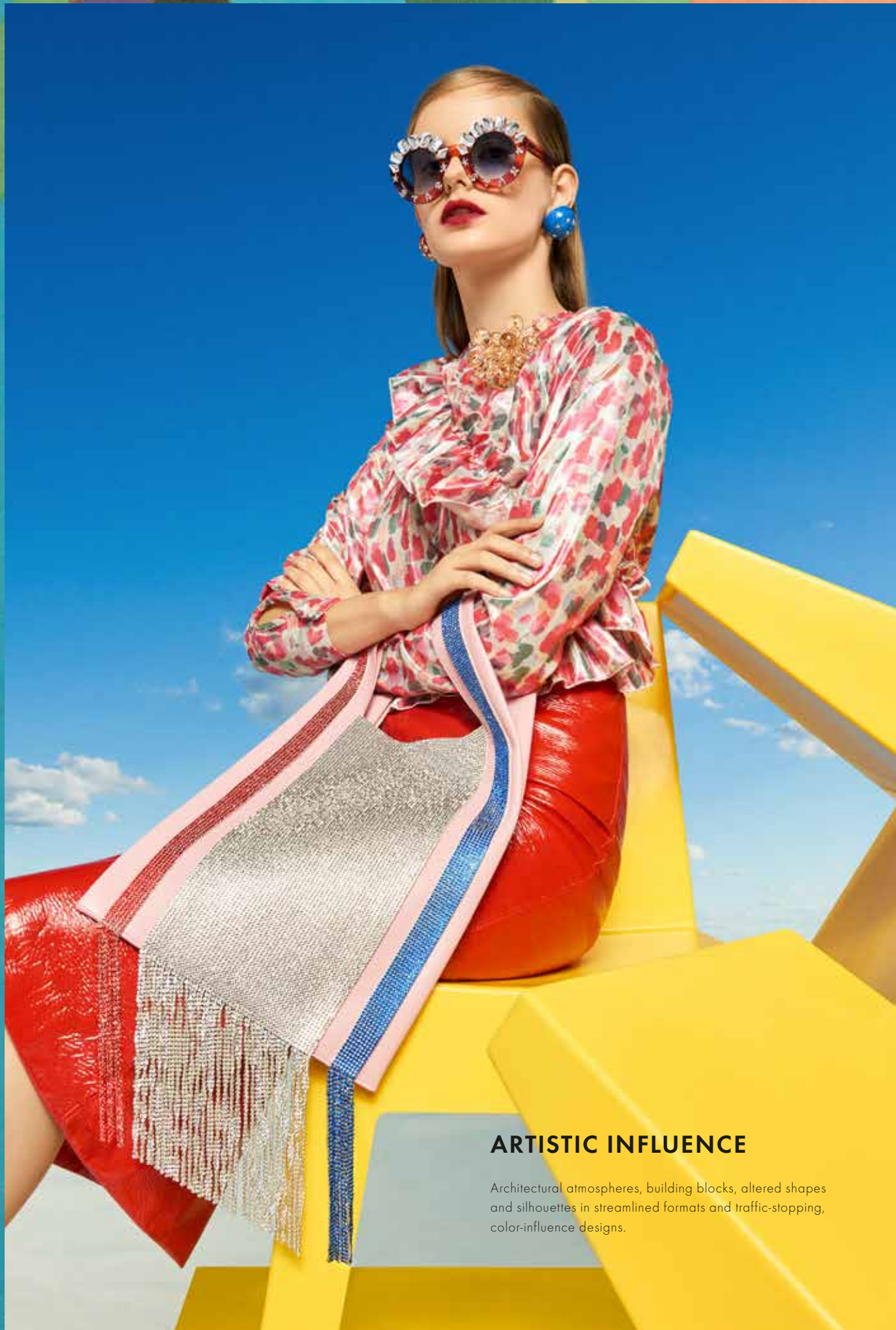

## ARTISTIC INFLUENCE

Architectural atmospheres, building blocks, altered shapes and silhouettes in streamlined formats and traffic-stopping, color-influence designs.

of  
gr  
to  
of h  
small, h  
alo  
Telo





## JEWELRY

Tapping into the Personalization Megatrend, attention-grabbing jewelry in vibrant colors, mixed gems, crystals and pearls become uniquely artistic pieces.

## TRAVEL ITEMS

Synthetic materials retain a matt surface and simple shapes allow for easy interchangeability as versatility in design gains importance.



### INNOVATIONS

- |  |   |  |
|--|---|--|
| <p><b>1</b> 86 301 Half Hole Pavé Ball</p> <p><b>2</b> SPIKE BEADS:<br/>5060 Hexagon Spike Bead<br/>5061 Square Spike Bead</p> <p><b>3</b> 3252 Emerald Cut Sew-on Stone</p> | <p><b>4</b> 1088 in Crystal Buttercup (001 L124S)<br/>4470 in Crystal Buttercup (001 L124S)</p> <p><b>5</b> 4470 in Crystal Lilac (001 L126S)</p> <p><b>6</b> GEOMETRIC FLAT BACKS:<br/>2771 Kite Flat Back<br/>2772 Trapeze Flat Back<br/>2773 Diamond Shape Flat Back</p> | <p><b>7</b> 4320 in Majestic Blue (296)<br/>4120 in Majestic Blue (296)<br/>5000 in Majestic Blue (296)<br/>5601 in Majestic Blue (296)</p> <p><b>8</b> 5950 Fine Rocks Tube with ending<br/>5951 Fine Rocks Tube without ending</p> <p><b>9</b> 4322 Teardrop Fancy Stone</p> |
|--|---|--|



Contemporary florals are re-created in whimsical crystal designs for this new direction







## ACCESSORIES

The continuing use of transparent materials in accessory directions is a direct reflection of the growing consumer demand for governments and companies to highlight the real, to have nothing hidden.



FREEDOM

FOLLOW THE SUN,  
IN ORDER TO FOLLOW  
YOUR DREAMS!



## FREE STYLIN'

Surf and skateboard references underline the homage being paid to a freer and a more balanced lifestyle for these new "transcendental travelers".





## FASHION

Re-inspiring a new generation – as they desire to reconnect with the past, nature and each other – “Now-stalgia” highlights a mash-up of vintage patterns, crystals and materials reflecting the free spirit.





## TRAVEL ITEMS

Only the bare necessities. Things you pack and carry – that also lift your heart – play into this young take on key-piece culture in free flow.

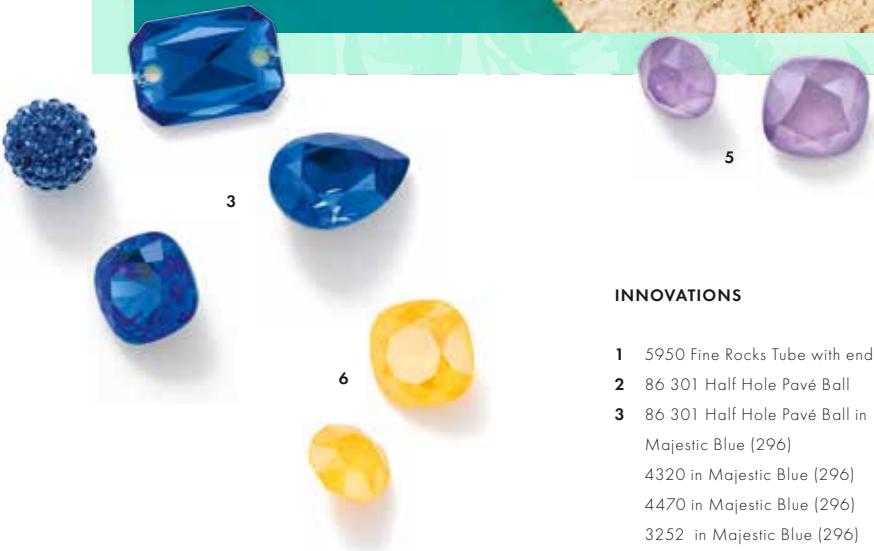

### INNOVATIONS

- |  |  |
|--|--|
| <p>1 5950 Fine Rocks Tube with ending</p> <p>2 86 301 Half Hole Pavé Ball</p> <p>3 86 301 Half Hole Pavé Ball in Majestic Blue (296)<br/>4320 in Majestic Blue (296)<br/>4470 in Majestic Blue (296)<br/>3252 in Majestic Blue (296)</p> | <p>4 4470 in Crystal Lime (001 L125S)<br/>1088 in Crystal Lime (001 L125S)</p> <p>5 4470 in Crystal Lilac (001 L126S)<br/>1088 in Crystal Lilac (001 L126S)</p> <p>6 4470 in Crystal Buttercup (001 L124S)<br/>1088 in Crystal Buttercup (001 L124S)</p> |
|--|--|



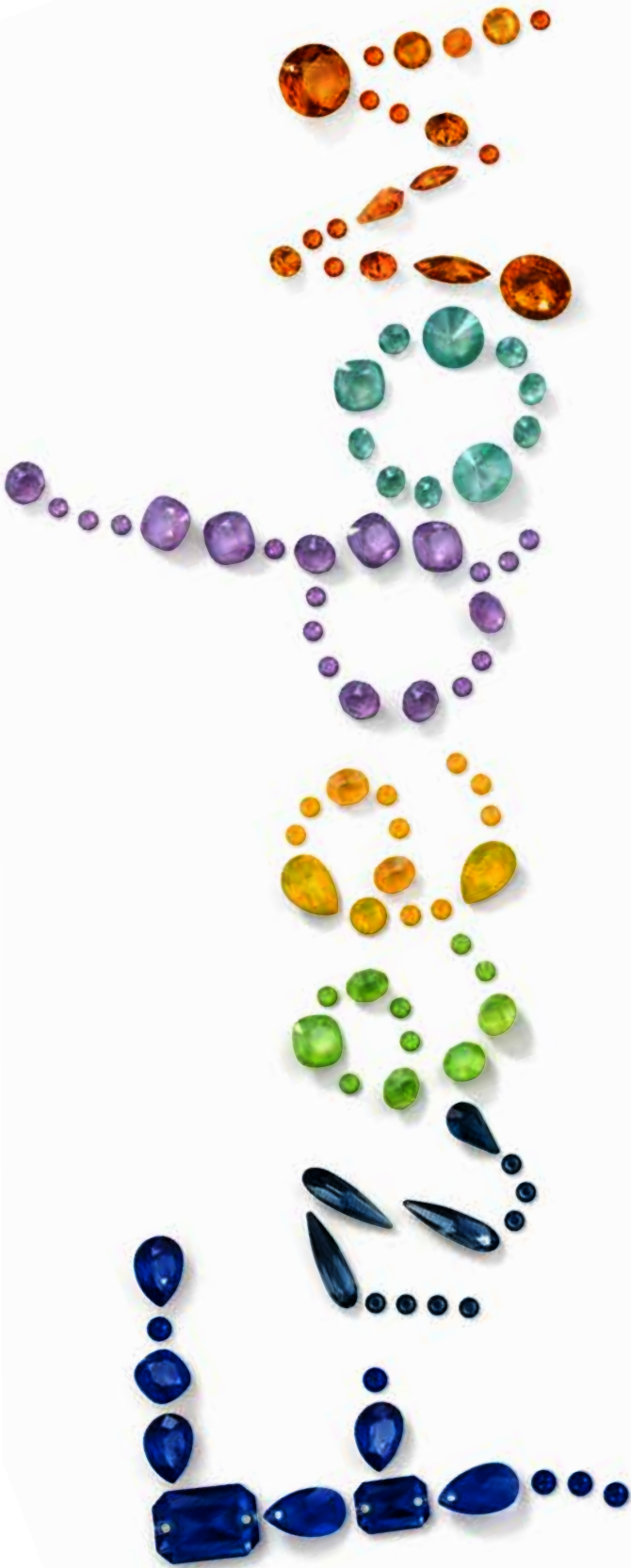

**SPELL IT OUT!**

Crystal slogans actively promote our beliefs and desires as part of the continuing customization trend.





## JEWELRY

Taking inspiration from natural elements, designers work with crystals and shells – worn as talismans for luck – to highlight the respect for nature inherent within surf culture.





# ADVENTURE

ADVENTURE

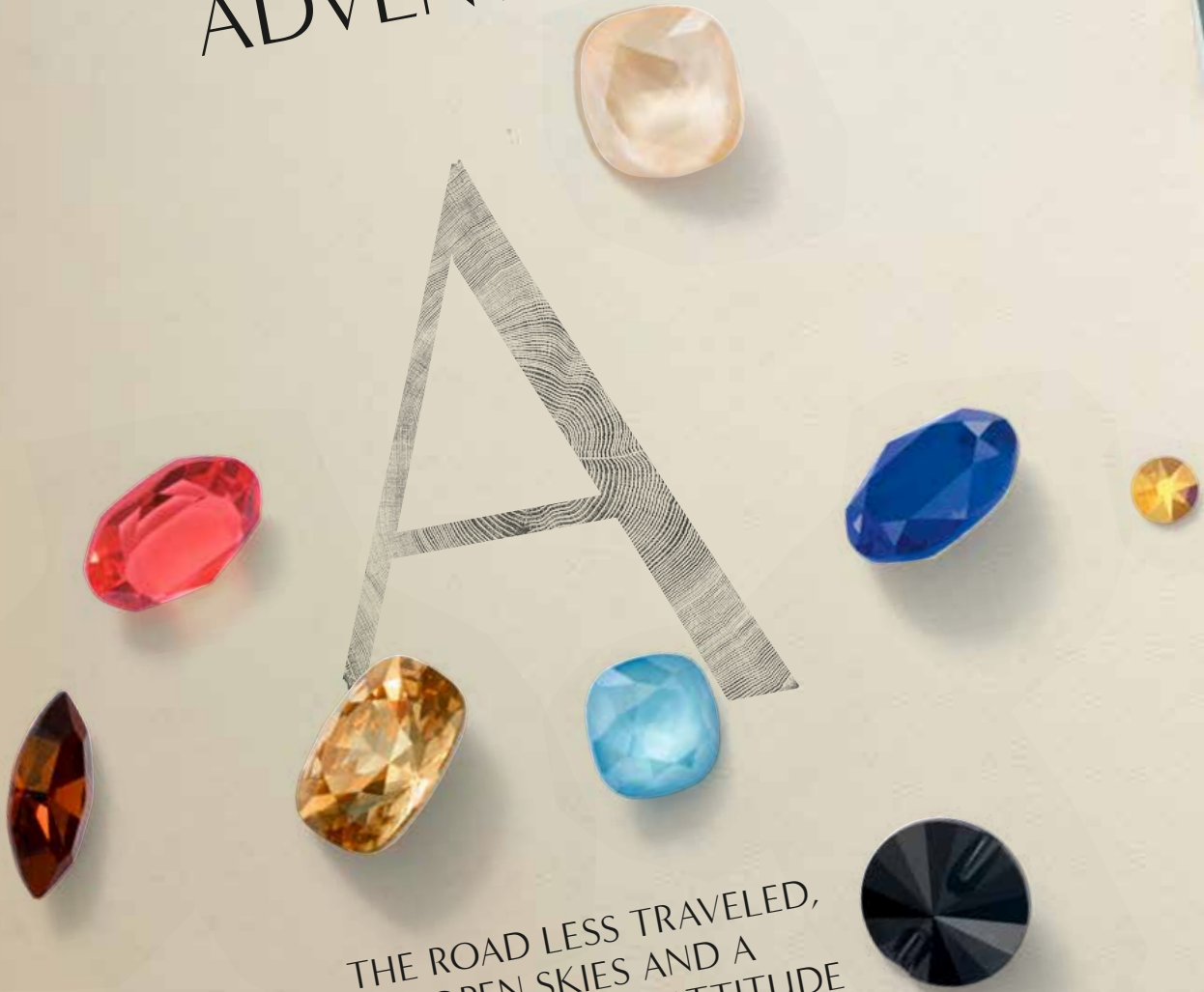

THE ROAD LESS TRAVELED,  
OPEN SKIES AND A  
DEVIL-MAY-CARE ATTITUDE  
ARE ALL THAT IS NEEDED.



## JOURNEY OF THE HEART

Down-to-earth and of the land, the majesty of nature is reflected in all its guises as old wisdom and new perspectives gain ground. From desert skies to dusty roads, the call of the great unknown is echoed in the rawness of organic design elements and dusky color palettes.



## JEWELRY

Brushed and gilded surfaces hold a handcrafted feel with crystals and gemstones inlaid and sliced to form new shapes.





# TRAVEL ITEMS

How travel – by horse, foot or even motorbike – highlights the need for functional design with a survivalist mentality, where everyday elements offer practical support.



## INNOVATIONS

- |  |  |  |
|--|--|--|
| <p>1 6430 Classic Cut Pendant</p> <p>2 5950 Fine Rocks Tube with ending</p> <p>3 3252 in Majestic Blue 296<br/>4470 in Majestic Blue 296<br/>4120 in Majestic Blue 296<br/>6228 in Majestic Blue 296<br/>5000 in Majestic Blue 296</p> | <p>4 SPIKE BEADS<br/>5060 Hexagon Spike Bead<br/>5061 Square Spike Bead<br/>5062 Round Spike Bead</p> <p>5 MINI SIZE FLAT BACKS<br/>2200 Navette Flat Back<br/>2400 Square Flat Back<br/>2711 Triangle Flat Back</p> | <p>6 GEOMETRIC FLAT BACKS<br/>2772 Trapeze Flat Back</p> <p>7 3252 Emerald Cut Sew-on Stone</p> <p>8 CRYSTAL MEDLEY<br/>73000 onwards in Jet Nut 280 NUT</p> |
|--|--|--|





ADVENTURE

## ACCESSORIES

Rough and tumble elements infiltrate fashion, with sturdy materials and well-worn leathers highlighting a “not-to-be-messed-with” attitude for a life on the move. Scuffed, hard-wearing leather boots and cross-body bags take center stage, as performance and functionality combine in one design.

Born out of necessity, strong fabrics like denim, suede and canvas are mixed. Ethnic prints and patchwork highlight a recycling ethos with fabrics pieced together to create a “world-traveler’s” uniform. Felt and broad brimmed hats offer practical protection from harsh external environments.









## JEWELRY

Ornamental designs pay homage to local and historical craftsmanship with treasures picked up along the journey.









LEISURE

TIME MAY BE THE TRUE LUXURY,  
BUT ELEGANCE NEVER GOES ASTRAY.

## JEWELRY

Beaten and molten metals in solid and flexible elements, are interspersed with crystal pearls to add even more interest to unique pieces.







## FASHION

Exquisite and exclusive, exaggerated all-over embellishment in intense silver sheens, appears like fish scales for streamlined sophistication.

## TRAVEL ITEMS

The devil is in the details, as a more streamlined direction emerges.

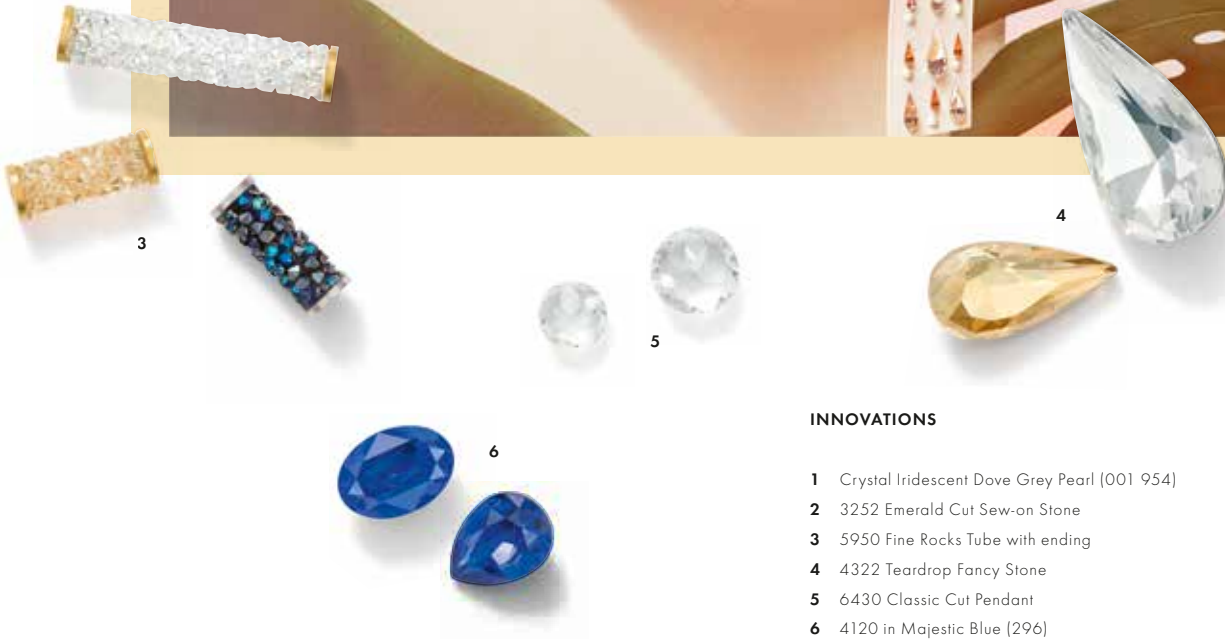

### INNOVATIONS

- 1 Crystal Iridescent Dove Grey Pearl (001 954)
- 2 3252 Emerald Cut Sew-on Stone
- 3 5950 Fine Rocks Tube with ending
- 4 4322 Teardrop Fancy Stone
- 5 6430 Classic Cut Pendant
- 6 4120 in Majestic Blue (296)  
4320 in Majestic Blue (296)
- 7 GEOMETRIC FLAT BACKS:  
2771 Kite Flat Back  
2772 Trapeze Flat Back  
2773 Diamond Shape Flat Back
- 8 86 301 Half Hole Pavé Ball
- 9 1088 in Crystal Lilac (001 L126S)





Crystal and pearl combinations in excessive floral formations, contrast in size and color to create sophisticated and elegant embellishment.

## JEWELRY

Oversized and embellished artful, transparent crystal jewelry complements the increasing "Glamcore" trend.







\*Crystal glass and all other materials containing 0.009% lead or less.

---

RESPONSIBILITY

## DOING BUSINESS IN A WAY THAT RESPECTS BOTH PEOPLE AND PLANET

---

FOUNDER DANIEL SWAROVSKI'S COMMITMENT TO RESPONSIBLE WORKING METHODS CONTINUES TO GUIDE OUR DECISIONS AND ACTIONS. WE HONOR HIS LEGACY WHILE ALSO RECOGNIZING THAT TODAY'S GLOBAL CHALLENGES NEED MODERN SOLUTIONS.

Climate change, water crises, gender inequality, economic disparity, forced labor, and the over-consumption of natural resources make it necessary for the private sector to step up. We have a role to play in tackling these challenges and working toward achieving the United Nations' Sustainable Development Goals.

Our vision is to drive positive change so that people understand that every time they buy Swarovski, they are contributing to a better world.

Accordingly, Swarovski has updated its sustainability strategy and priorities regarding where we can deploy our unique strengths so that they have the greatest impact across our value chain. We also continually collaborate with the fashion, jewelry and design industries to improve our sector's commitment to ethical working practices. To this end, Swarovski strives to develop creative solutions that promote the responsible use of materials and resources and have a positive impact on the lives of those who make, use and wear our products.







---

INNOVATIONS OVERVIEW

THE TIME IS  
**NOW**

---

A sudden stroke of brilliance is nothing if not timely. But when opportunity knocks will you be listening? For sparkling designs filled with promise, for inspiration as Majestic Blue as the swell of the sea, for cohesive patterns as spellbinding as a kaleidoscope, and for designs that dazzle in any era, look no further than Swarovski's latest Spring/Summer 2019 innovations.







---

41	Why Swarovski
42	Product Overview
48	Round Stones
50	Fancy Stones & Settings
57	Beads
62	BeCharmed & Pavé
66	Crystal Pearls
67	Pendants
69	Flat Backs No Halfix
73	Flat Backs Halfix
78	Sew-on Articles
82	Transfers
91	Synthetics
96	Metal Trimmings
104	Crystal Mesh
108	Crystal Inspiration Collection

# WHY SWAROVSKI

## EXCELLENCE, THROUGH INNOVATION AND ORIGIN

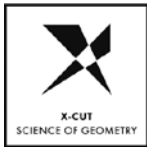

### X-CUT

Advanced optical measurement and high-precision manufacturing deliver premium cuts characterized by unmatched brilliance.



### PLATINUM\* PRO

With its new advanced foiling technique, Swarovski has set a new standard in the lifespan of crystals.



### HOTFIX GLUE

The variable temperatures at which Hotfix glue can be activated enable the application of crystals on a broad range of textiles.



### CRYSTALS – MADE IN AUSTRIA

The combination of innovation with sustainability and respect for individual wellbeing means that quality is always assured.

## PREMIUM, BY SERVICE AND DESIGN



### DESIGN SERVICE

Throughout its global network of Design Centers, Swarovski offers exceptional service provided by the industry's best creative talent.



### APPLICATION SERVICE

A comprehensive range of application services means customers benefit from the extensive experience of leading international experts, as well as internal specialists.



### GLOBAL SERVICE

Swarovski's Global Service Network provides customers with dedicated personal assistance on a local level.



### DESIGNER EDITIONS

Creative collaborations with top designers result in exclusive cuts and unique designs for Swarovski crystals.

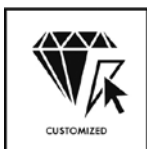

### CUSTOMIZED SERVICE

Choose new variations by going beyond Swarovski's tremendous standard assortment of crystal components and forward integrated elements.

## COMPLIANCE, WITH INTEGRITY



### ADVANCED CRYSTAL

Swarovski's patented lead-free\*\* formula has changed the DNA of crystal while still offering the same sparkle, dependability, and variety for which Swarovski is famous.



### OEKO-TEX

Oeko-Tex® Standard 100 Class II (direct contact with skin) certification creates confidence in chemical safety of textile applications.



### CLEAR

Regular legal monitoring of chemical requirements and reasonable testing provide customers with the comfort of trust in Swarovski's products.



### COMPLIANCE SERVICE

Assessments regarding substance limitations as well as compliance information and advice to support customers in complying with relevant laws, regulations, and voluntary standards.

\* Silver mirror coated with a platinum colored protective layer.

\*\* Crystal glass and all other materials containing 0.009% lead or less.



# PRODUCT OVERVIEW

## NEW CRYSTAL ELEMENTS

### Fancy Stones & Settings



**4322** Teardrop Fancy Stone  
10x5, 14x7, 18x9, 22x11, 30x15 mm



**4322/S**  
10x5, 14x7, 18x9, 22x11, 30x15 mm

### BeCharmed & Pavé



**82 201** Letter Bead  
12x11 mm Stainless Steel



**86 301** Half Hole Pavé Ball  
6, 8, 10 mm

### Flat Backs No Hotfix



**2771** Kite Flat Back  
6.4x4.2, 8.6x5.6, 12.9x8.3 mm



**2772** Trapeze Flat Back  
6.5x2.1, 8.6x2.8, 12.9x4.2 mm



**2773** Diamond Shape Flat Back  
5x3, 6.6x3.9, 9.9x5.9 mm

### Sew-on Articles



**3252** Emerald Cut Sew-on Stone  
14x10, 20x14, 28x20 mm

### Beads



**5060** Hexagon Spike Bead  
5.5, 7.5 mm



**5061** Square Spike Bead  
5.5, 7.5 mm



**5062** Round Spike Bead  
5.5, 7.5 mm



**5950** Fine Rocks Tube with ending  
15, 30 mm



**5951** Fine Rocks Tube without ending  
15, 30 mm

### Pendants



**6430** Classic Cut Pendant  
8, 10, 14 mm

### Flat Backs Hotfix



**2771** Kite Flat Back  
6.4x4.2, 8.6x5.6, 12.9x8.3 mm



**2772** Trapeze Flat Back  
6.5x2.1, 8.6x2.8, 12.9x4.2 mm



**2773** Diamond Shape Flat Back  
5x3, 6.6x3.9, 9.9x5.9 mm

PRODUCT OVERVIEW

## LINE EXTENSIONS

### New Sizes for Mini Size Flat Backs

**2200** 4x2 mm  
**2400** 2.2 mm  
**2711** 3.3 mm

### New Colors for Pavé Ball

Light Colorado Topaz Shimmer (246 971)  
Light Sapphire Shimmer (211 971)  
Light Siam Shimmer (227 971)

### New Effect for Crystal Galuchat

Jet Hematite (280 HEM)

### New Effect for Crystal Medley

Jet Nut (280 NUT)

### New Casing Color for Crystal Mesh Standard

088 Stainless Steel

**NEW COLOR**

When we dream of far-away places, the background of a perfect holiday is always a quality of blue we're calling Majestic. This versatile new color option, which is as intense as the sea and as clear as the wide-open sky, will be available in a variety of cuts and shapes for various applications.



Majestic Blue  
(296)

**Round Stones**

**1028**  
PP 3, 4, 5, 6, 9, 10, 11, 13

**1088**  
PP 14, 18, 21, 24, 31, 32  
SS 19, 24, 29, 34, 39, 45

**1122**  
SS 29, 39, 47  
12, 14, 18 mm

**Fancy Stones & Settings**

**4120**  
6x4, 8x6, 14x10, 18x13,  
25x18 mm

**4127**  
30x22 mm

**4161**  
15x5, 21x7, 27x9 mm

**4228**  
4x2, 5x2.5, 6x3, 8x4, 10x5,  
15x7 mm

**4320**  
6x4, 8x6, 10x7, 14x10,  
18x13 mm

**4322**  
10x5, 14x7, 18x9, 22x11,  
30x15 mm

**4327**  
30x20 mm

**4328**  
6x3.6, 8x4.8, 10x6,  
13x7.8 mm

**4428**  
2, 3, 4, 6, 8 mm

**4470**  
10, 12 mm

**Beads**

**5000**  
2, 3, 4, 6, 8, 10 mm

**5328**  
3, 4, 5, 6, 8 mm

**5601**  
4, 6 mm

**BeCharmed & Pavé**

**80 101**  
13.5x6.7 mm

**81 101**  
14x9.3 mm

**86 001**  
6, 8, 10 mm

**86 301**  
6, 8, 10 mm

**Pendants**

**6000**  
11x5.5 mm

**6106**  
16, 22 mm

**6228**  
10.3x10, 14.4x14,  
18x17.5 mm

**6428**  
8 mm

**Flat Backs No Hotfix**

**2058**  
SS 5, 7, 9

**2088**  
SS 12, 16, 20, 30, 34

**Flat Backs Hotfix**

**2038**  
SS 6, 8, 10

**2078**  
SS 12, 16, 20, 34

**Sew-on Articles**

**3252**  
14x10, 20x14 mm

**Transfers**

**2038**  
SS 6, 8, 10

**2078**  
SS 12, 16, 20, 34

**Metal Trimmings**

**55 000, 55 001**  
SS 20

**55 300, 55 301**  
SS 16

**55 500, 55 501**  
SS 12

**55 100/55 200,  
55 101/55 201 onwards**

**53 001, 53 005, 53 006,  
53 008**  
SS 29, 34, 39; PP 24

**53 301, 53 302,  
53 303, 53 304**  
SS 10, 16, 20, 34

**53 100, 53 102,  
53 103**  
SS 12, 16, 30

**54 001, 54 002,  
54 003**  
SS 16

**Crystal Mesh**

**40 000, 40 001**  
PP 21

**40 600, 40 601**  
PP 9

\* Majestic Blue's intense ultramarine hue is difficult to recreate accurately in print due to the fact that the CMYK color spectrum is used in the printing process. In order to get a truer impression of its color, please use RGB digital pictures or, ideally, ask for actual samples.



**NEW CRYSTAL SHINY LACQUER<sup>PRO</sup> EFFECTS**

The New Crystal Shiny Lacquer<sup>PRO</sup> Effects Buttercup, Lime and Lilac answer our need for refined shine and uplifting hues. A perfect match for elegant styles, bold streamlined designs, or expressive

looks. The new Crystal Shiny Lacquer<sup>PRO</sup> Colors also offer exciting fresh designs possibilities when combined with Majestic Blue.



**Crystal Buttercup  
(001 L124S)**



**Crystal Lilac  
(001 L126S)**



**Crystal Lime  
(001 L125S)**

PRODUCT OVERVIEW

**Round Stones**



**1088**  
SS 29, 39



**1122**  
12, 14 mm

**Flat Backs No Hotfix**



**2088**  
SS 12, 16, 20, 30

**Flat Backs Hotfix**



**2038**  
SS 10



**2078**  
SS 16, 34

**Metal Trimmings**



**55 000, 55 001**  
SS 20



**55 300, 55 301**  
SS 16



**55 500, 55 501**  
SS 12



**55 100/55 200,  
55 101/55 201 onwards**

**Fancy Stones & Settings**



**4120**  
14x10, 18x13 mm



**4122**  
8x6, 14x10.5, 18x13.5 mm



**4127**  
30x22 mm



**4320**  
14x10, 18x13 mm



**4327**  
30x20 mm



**4470**  
10, 12 mm

**Transfers**



**2038**  
SS 10



**2078**  
SS 16, 34

All available Crystal Shiny Lacquer<sup>PRO</sup> effects



Crystal Ivory Cream  
(001 L106S)



Crystal Buttercup  
(001 L124S) **NEW**

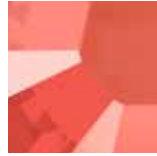

Crystal Light Coral  
(001 L116S)



Crystal Royal Red  
(001 L107S)



Crystal Dark Red  
(001 L108S)



Crystal Peony Pink  
(001 L113S)



Crystal Lilac  
(001 L126S) **NEW**



Crystal Summer Blue  
(001 L114S)



Crystal Azure Blue  
(001 L112S)



Crystal Royal Blue  
(001 L110S)



Crystal Royal Green  
(001 L109S)



Crystal Lime  
(001 L125S) **NEW**



Crystal Mint Green  
(001 L115S)

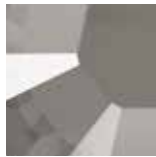

Crystal Dark Grey  
(001 L111S)

All available Crystal Lacquer<sup>PRO</sup> Powder effects



Crystal Powder Yellow  
(001 L101)



Crystal Powder Rose  
(001 L103)



Crystal Powder Blue  
(001 L104)



Crystal Powder Green  
(001 L102)



Crystal Powder Grey  
(001 L105)



---

## NEW CRYSTAL PEARL COLOR

Elegant and refined, the new Crystal Iridescent Dove Grey Pearl speaks to myriad design directions and exquisitely complements the new Majestic Blue in sophisticated and glamorous designs.



Crystal Iridescent  
Dove Grey Pearl  
(001 954)

### Crystal Pearls



**5810**  
3, 4, 5, 6, 8, 10, 12 mm



**5818**  
3, 4, 6, 8, 10 mm



**5817**  
6, 8, 10 mm



**5860**  
10, 12 mm

# SETTINGS SUMMARY FOR SPRING/SUMMER 2019

Following the launch of Swarovski's new settings in Spring/Summer 2018, we are delighted to extend it in Spring/Summer 2019. Chief among the benefits of the additions is the use of Tombac as a base material—a brass alloy containing 85% copper that offers superb deformability, strength, and hard soldering capability. Further improvements include prongs with new premium-looking

rounded edges; an advanced fit that minimizes the setting height; plating layers that exceed the market standard; and holes positioned further apart to maximize stability. With shorter lead times and, in some cases, reduced prices too, these new settings will make a significant difference to your use of Swarovski settings.

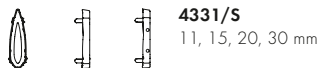
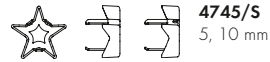
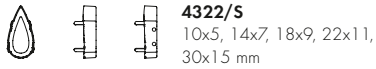
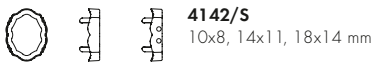
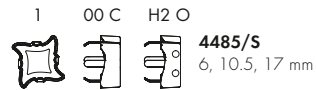



# ROUND STONES

## 1028 XILLION Chaton

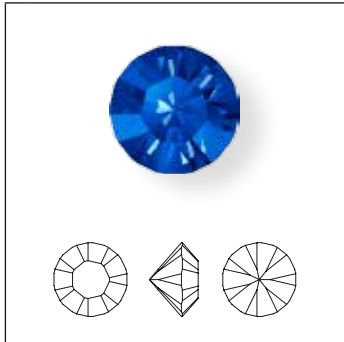

Size	PP 3	PP 4	PP 5	PP 6	PP 7	PP 9	PP 10	PP 11	PP 13
<b>Colors</b>									
<b>Plain Colors</b>									
Majestic Blue F (296)	NEW!	■	■	■	■	■	■	■	■
<b>Color Effects</b>									
<b>Transparent Effects</b>									
Black Diamond Shimmer F (215 971)						NEW!			
Light Colorado Topaz Shimmer F (246 971)						NEW!			
Light Sapphire Shimmer F (211 971)						NEW!			
Light Siam Shimmer F (227 971)						NEW!			

## 1088 XIRIUS Chaton

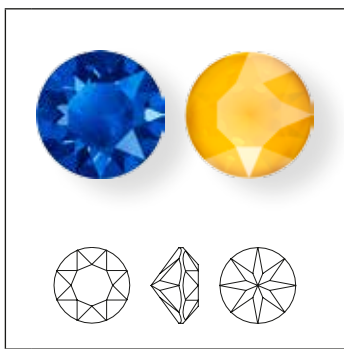

Size	PP 14	PP 18	PP 21	PP 24	PP 31	PP 32	SS 19	SS 24	SS 29	SS 34	SS 39	SS 45
<b>Colors</b>												
<b>Plain Colors</b>												
Majestic Blue F (296)	NEW!	■	■	■	■	■	■	■	■	■	■	■
<b>Crystal Effects</b>												
<b>Crystal Laquer<sup>PRO</sup></b>												
Crystal Buttercup (001 L124S)	NEW!								■		■	
Crystal Lilac (001 L126S)	NEW!								■		■	
Crystal Lime (001 L125S)	NEW!								■		■	

ROUND STONES

1122 Rivoli

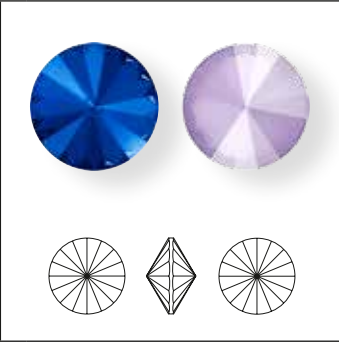

Size	SS 29	SS 39	SS 47	12 mm	14 mm	18 mm
------	-------	-------	-------	-------	-------	-------

Colors

Plain Colors

Majestic Blue F (296)

Crystal Effects

Crystal Laquer<sup>PRO</sup>

Crystal Buttercup (001 L124S)

Crystal Lilac (001 L126S)

Crystal Lime (001 L125S)

NEW!	■	■	■	■	■	■
NEW!				■	■	
NEW!				■	■	
NEW!				■	■	



# FANCY STONES & SETTINGS

## 4120



Size	6x4 mm	8x6 mm	14x10 mm	18x13 mm	25x18 mm
------	--------	--------	----------	----------	----------

**Colors**

**Plain Colors**

Majestic Blue F (296)	NEW!	<input type="checkbox"/>	<input type="checkbox"/>	<input type="checkbox"/>	<input type="checkbox"/>
-----------------------	------	--------------------------	--------------------------	--------------------------	--------------------------

**Crystal Effects**

**Crystal Laquer<sup>PRO</sup>**

Crystal Buttercup (001 L124S)	NEW!	<input type="checkbox"/>	<input type="checkbox"/>	<input type="checkbox"/>	<input type="checkbox"/>
Crystal Lilac (001 L126S)	NEW!	<input type="checkbox"/>	<input type="checkbox"/>	<input type="checkbox"/>	<input type="checkbox"/>
Crystal Lime (001 L125S)	NEW!	<input type="checkbox"/>	<input type="checkbox"/>	<input type="checkbox"/>	<input type="checkbox"/>

## 4122 Oval Rivoli Fancy Stone

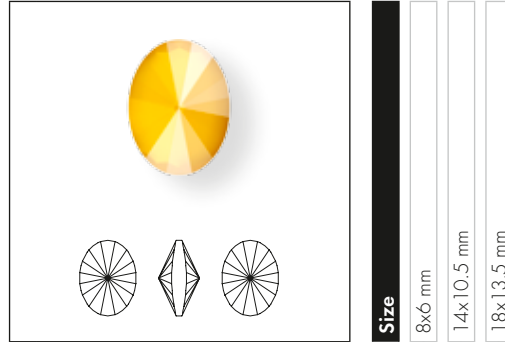

Size	8x6 mm	14x10.5 mm	18x13.5 mm
------	--------	------------	------------

**Crystal Effects**

**Crystal Laquer<sup>PRO</sup>**

Crystal Buttercup (001 L124S)	NEW!	<input type="checkbox"/>	<input type="checkbox"/>	<input type="checkbox"/>
Crystal Lilac (001 L126S)	NEW!	<input type="checkbox"/>	<input type="checkbox"/>	<input type="checkbox"/>
Crystal Lime (001 L125S)	NEW!	<input type="checkbox"/>	<input type="checkbox"/>	<input type="checkbox"/>

## 4127

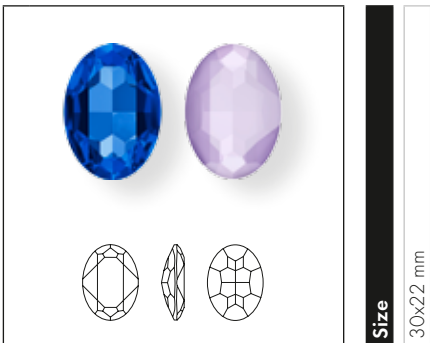

Size	30x22 mm
------	----------

**Colors**

**Plain Colors**

Majestic Blue F (296)	NEW!	<input type="checkbox"/>
-----------------------	------	--------------------------

**Crystal Effects**

**Crystal Laquer<sup>PRO</sup>**

Crystal Buttercup (001 L124S)	NEW!	<input type="checkbox"/>
Crystal Lilac (001 L126S)	NEW!	<input type="checkbox"/>
Crystal Lime (001 L125S)	NEW!	<input type="checkbox"/>

**4161** Long Classical Oval Fancy Stone

**Size**  
15x5 mm  
21x7 mm  
27x9 mm

**Colors**

**Plain Colors**  
● Majestic Blue F (296)

NEW!

**4228** XILION Navette Fancy Stone

**Size** 4x2, 5x2.5 mm

**4228**

**Size**  
4x2 mm  
5x2.5 mm  
6x3 mm  
8x4 mm  
10x5 mm  
15x7 mm

**Colors**

**Plain Colors**  
● Majestic Blue F (296)

NEW!

**4228** XILION Navette Fancy Stone

**Size** 6x3, 8x4, 10x5, 15x7 mm



4320

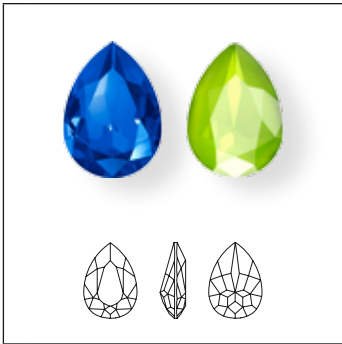

Size	6x4 mm	8x6 mm	10x7 mm	14x10 mm	18x13 mm
------	--------	--------	---------	----------	----------

**Colors**

**Plain Colors**

 Majestic Blue F (296)

NEW!	<input checked="" type="checkbox"/>	<input checked="" type="checkbox"/>	<input checked="" type="checkbox"/>	<input checked="" type="checkbox"/>	<input checked="" type="checkbox"/>
------	-------------------------------------	-------------------------------------	-------------------------------------	-------------------------------------	-------------------------------------

**Crystal Effects**

**Crystal Laquer<sup>PRO</sup>**

 Crystal Buttercup (001 L124S)

NEW!	<input type="checkbox"/>	<input type="checkbox"/>	<input type="checkbox"/>	<input checked="" type="checkbox"/>	<input checked="" type="checkbox"/>
------	--------------------------	--------------------------	--------------------------	-------------------------------------	-------------------------------------

 Crystal Lilac (001 L126S)

NEW!	<input type="checkbox"/>	<input type="checkbox"/>	<input type="checkbox"/>	<input checked="" type="checkbox"/>	<input checked="" type="checkbox"/>
------	--------------------------	--------------------------	--------------------------	-------------------------------------	-------------------------------------

 Crystal Lime (001 L125S)

NEW!	<input type="checkbox"/>	<input type="checkbox"/>	<input type="checkbox"/>	<input checked="" type="checkbox"/>	<input checked="" type="checkbox"/>
------	--------------------------	--------------------------	--------------------------	-------------------------------------	-------------------------------------

4322 Teardrop Fancy Stone <sup>NEW!</sup>

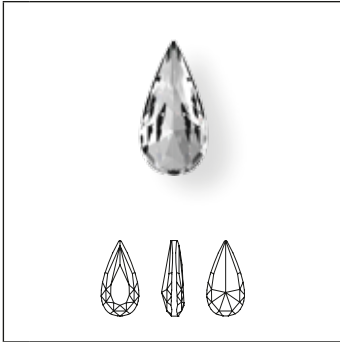

Size	10x5 mm	14x7 mm	18x9 mm	22x11 mm	30x15 mm
------	---------	---------	---------	----------	----------

**Crystal**

Crystal F (001)

**Colors**

**Plain Colors**

Amethyst F (204)

Aquamarine F (202)

Black Diamond F (215)

Denim Blue F (266)

Emerald F (205)

Jet (280)

Light Colorado Topaz F (246)

Majestic Blue F (296) <sup>NEW!</sup>

Montana F (207)

Scarlet F (276)

Tanzanite F (539)

Vintage Rose F (319)

**Crystal Effects**

**Transparent Effects**

Crystal AB F (001 AB)

Crystal Antique Pink F (001 ANTP)

Crystal Golden Shadow F (001 GSHA)

Crystal Silver Night (001 SINI)

Crystal Silver Shade F (001 SSHA)

Crystal F (001)	■	■	■	■	■
Amethyst F (204)	■	■	■	■	■
Aquamarine F (202)	■	■	■	■	■
Black Diamond F (215)	■	■	■	■	■
Denim Blue F (266)	■	■	■	■	■
Emerald F (205)	■	■	■	■	■
Jet (280)	■	■	■	■	■
Light Colorado Topaz F (246)	■	■	■	■	■
Majestic Blue F (296) <sup>NEW!</sup>	■	■	■	■	■
Montana F (207)	■	■	■	■	■
Scarlet F (276)	■	■	■	■	■
Tanzanite F (539)	■	■	■	■	■
Vintage Rose F (319)	■	■	■	■	■
Crystal AB F (001 AB)	■	■	■	■	■
Crystal Antique Pink F (001 ANTP)	■	■	■	■	■
Crystal Golden Shadow F (001 GSHA)	■	■	■	■	■
Crystal Silver Night (001 SINI)	■	■	■	■	■
Crystal Silver Shade F (001 SSHA)	■	■	■	■	■

4322/S <sup>NEW!</sup>

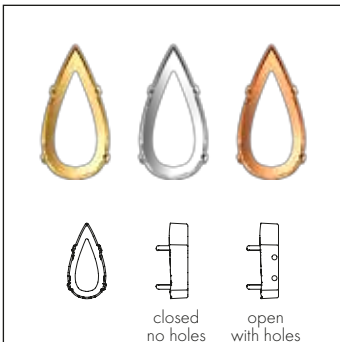

Size & color of plating	10x5 mm No plating	14x7 mm No plating	18x9 mm No plating	22x11 mm No plating	30x15 mm No plating	10x5 mm Rhodium	14x7 mm Rhodium	18x9 mm Rhodium	22x11 mm Rhodium	30x15 mm Rhodium	10x5 mm Gold	14x7 mm Gold	18x9 mm Gold	22x11 mm Gold	30x15 mm Gold
-------------------------	--------------------	--------------------	--------------------	---------------------	---------------------	-----------------	-----------------	-----------------	------------------	------------------	--------------	--------------	--------------	---------------	---------------

**Ring/Hole, Back Configuration**

00 C = No ring/hole, closed

H2 O = 4 holes/2 each side, open

00 C = No ring/hole, closed	■	■	■	■	■	■	■	■	■	■	■	■	■	■	■
H2 O = 4 holes/2 each side, open	■	■	■	■	■	■	■	■	■	■	■	■	■	■	■

4327

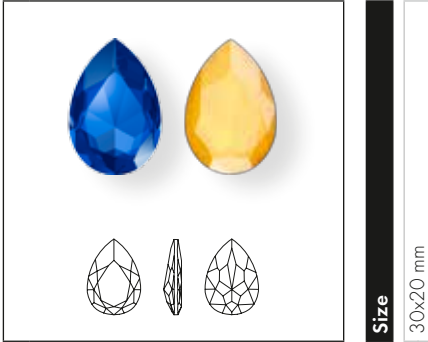

Size

30x20 mm

Colors

Plain Colors

Majestic Blue F (296) **NEW!**

Crystal Effects

Crystal Laquer<sup>PRO</sup>

Crystal Buttercup (001 L124S) **NEW!**

Crystal Lilac (001 L126S) **NEW!**

Crystal Lime (001 L125S) **NEW!**

4328 XILION Pear Fancy Stone



Size

6x3.6 mm

8x4.8 mm

10x6 mm

13x7.8 mm

Colors

Plain Colors

Majestic Blue F (296) **NEW!**



4428 XILION Square Fancy Stone

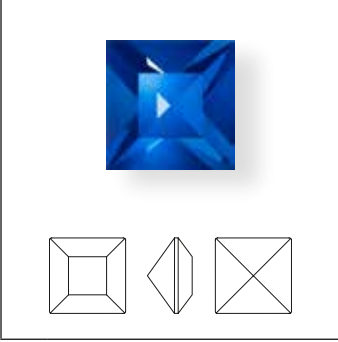

Size 2 mm

4428 XILION Square Fancy Stone

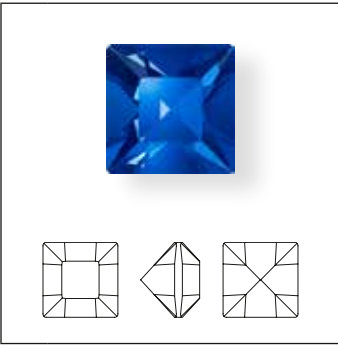

Size 3, 4 mm

4428 XILION Square Fancy Stone

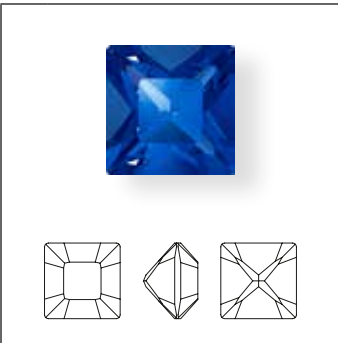

Size 6, 8 mm

4428	Size	2 mm	3 mm	4 mm	6 mm	8 mm
		Colors	Plain Colors			
		NEW!				
		Majestic Blue F (296)				

4470

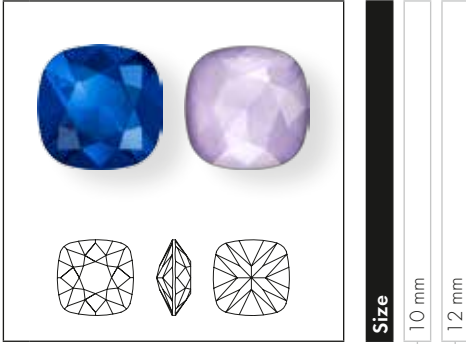

Size

10 mm

12 mm

Colors

Plain Colors

 Majestic Blue F (296)

NEW!

Crystal Effects

Crystal Laquer<sup>PRO</sup>

 Crystal Buttercup (001 L124S)

NEW!

 Crystal Lilac (001 L126S)

NEW!

 Crystal Lime (001 L125S)

NEW!

# BEADS

5000

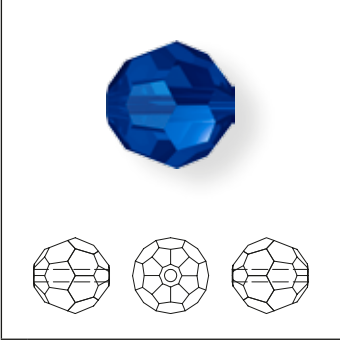

Size
2 mm
3 mm
4 mm
6 mm
8 mm
10 mm

Colors
Plain Colors
<span style="color: blue;">●</span> Majestic Blue [296]





**SPIKE BEADS**

**5060 Hexagon Spike Bead** NEW!

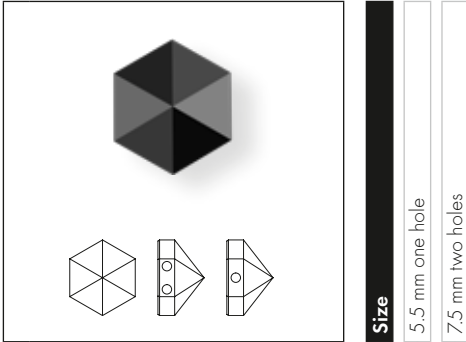

**Size**

5.5 mm one hole

7.5 mm two holes

**Crystal**

Crystal (001)

**Colors**

**Plain Colors**

Jet (280)

**Crystal Effects**

**Transparent Effects**

Crystal AB (001 AB)

Crystal Blue Shade (001 BLSH)

Crystal Golden Shadow (001 GSHA)

Crystal Paradise Shine (001 PARSH)

Crystal Silver Night (001 SINI)

**Metallic Effects**

Crystal Light Chrome (001 LTCH)

Crystal Metallic Blue (001 METBL)

Crystal Metallic Light Gold (001 MLG)

Crystal Rose Gold (001 ROGL)

**Color Effects**

**Metallic Effects**

Jet Hematite (280 HEM)

**5061 Square Spike Bead** NEW!

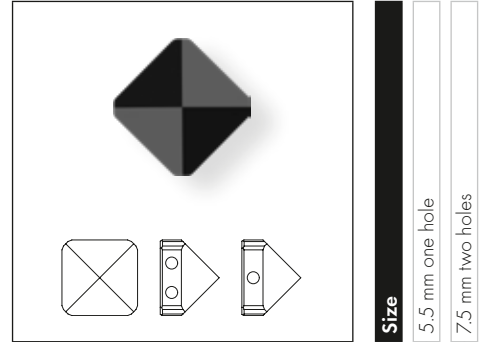

**Size**

5.5 mm one hole

7.5 mm two holes

**Crystal**

Crystal (001)

**Colors**

**Plain Colors**

Jet (280)

**Crystal Effects**

**Transparent Effects**

Crystal AB (001 AB)

Crystal Blue Shade (001 BLSH)

Crystal Golden Shadow (001 GSHA)

Crystal Paradise Shine (001 PARSH)

Crystal Silver Night (001 SINI)

**Metallic Effects**

Crystal Light Chrome (001 LTCH)

Crystal Metallic Blue (001 METBL)

Crystal Metallic Light Gold (001 MLG)

Crystal Rose Gold (001 ROGL)

**Color Effects**

**Metallic Effects**

Jet Hematite (280 HEM)

**5062 Round Spike Bead** NEW!

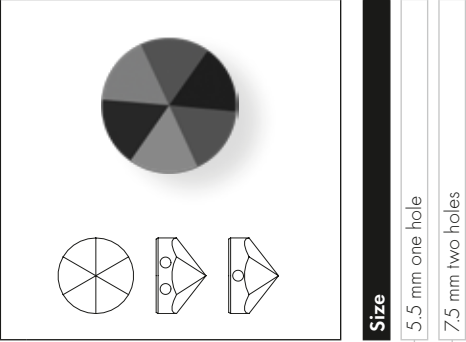

**Size**

5.5 mm one hole

7.5 mm two holes

Crystal		
	Crystal (001)	■ ■
Colors		
Plain Colors		
	Jet (280)	■ ■
Crystal Effects		
Transparent Effects		
	Crystal AB (001 AB)	■ ■
	Crystal Blue Shade (001 BLSH)	■ ■
	Crystal Golden Shadow (001 GSHA)	■ ■
	Crystal Paradise Shine (001 PARSH)	■ ■
	Crystal Silver Night (001 SINI)	■ ■
Metallic Effects		
	Crystal Light Chrome (001 LTCH)	■ ■
	Crystal Metallic Blue (001 METBL)	■ ■
	Crystal Metallic Light Gold (001 MLG)	■ ■
	Crystal Rose Gold (001 ROGL)	■ ■
Color Effects		
Metallic Effects		
	Jet Hematite (280 HEM)	■ ■

**5328 XILION Bead**

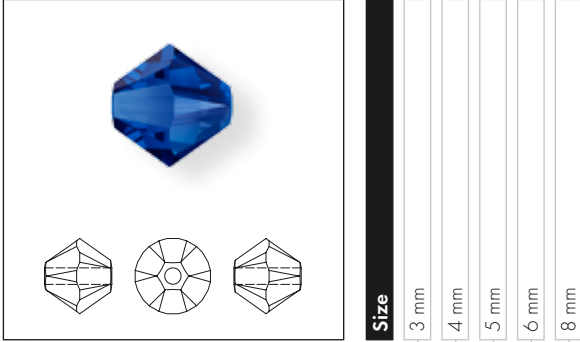

- Colors**
- Plain Colors**
- Majestic Blue (296)
- Color Effects**
- Transparent Effects**
- Majestic Blue AB (296 AB)
- Majestic Blue AB 2x (296 AB2)

Size	3 mm	4 mm	5 mm	6 mm	8 mm
Majestic Blue (296)	NEW!	■	■	■	■
Majestic Blue AB (296 AB)	NEW!	■	■	■	■
Majestic Blue AB 2x (296 AB2)	NEW!	■	■	■	■

**5601**

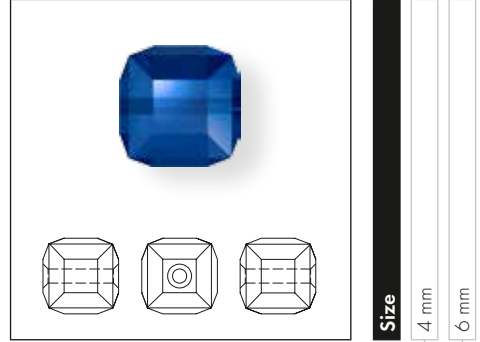

- Colors**
- Plain Colors**
- Majestic Blue (296)

Size	4 mm	6 mm
Majestic Blue (296)	■	■



**FINE ROCKS TUBE**

**5950** Fine Rocks Tube with ending <sup>NEW!</sup>



- Crystal Effects**
- Transparent Effects**
- Crystal Bermuda Blue (001 BBL)
- Crystal Golden Shadow (001 GSHA)
- Crystal Moonlight (001 MOL)
- Metallic Effects**
- Crystal Light Chrome (001 LTCH)
- Multicolors**
- Jet &
- Crystal Metallic Silver (001 M100)

**5951** Fine Rocks Tube without ending <sup>NEW!</sup>

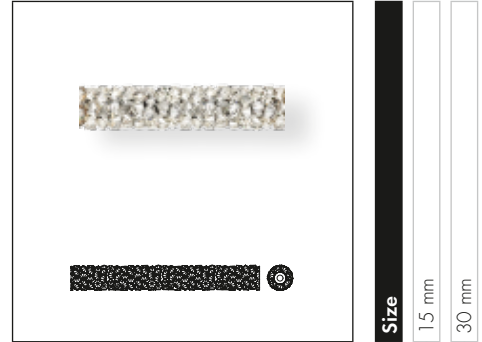

- Crystal Effects**
- Transparent Effects**
- Crystal Bermuda Blue (001 BBL)
- Crystal Golden Shadow (001 GSHA)
- Crystal Moonlight (001 MOL)
- Metallic Effects**
- Crystal Light Chrome (001 LTCH)
- Multicolors**
- Jet &
- Crystal Metallic Silver (001 M100)

**Overview of all available Colors of Metal Part**

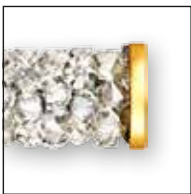

081 Gold Coating



088 Stainless Steel

**Care Instructions**



Turn inside out and use mild laundry detergent (wash by hand, max. temp. 30°C, very mild process).



Do not use chlorine bleach!



Do not tumble dry!



Do not iron!

# BECHARMED & PAVÉ

## PAVÉ BEADS

**80 101** BeCharmed Pavé Bead

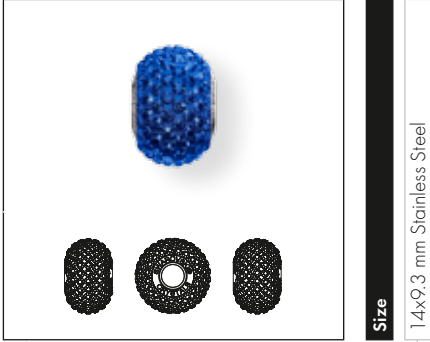

**Colors**

**Plain Colors**

- [Majestic Blue \(296\)](#)
- [Dark Sapphire \(15\)](#)

NEW!

**81 101** BeCharmed Pavé Bead Slim



**Colors**

**Plain Colors**

- [Majestic Blue \(296\)](#)
- [Dark Sapphire \(15\)](#)

NEW!

PAVÉ BALL

86 001 Pavé Ball

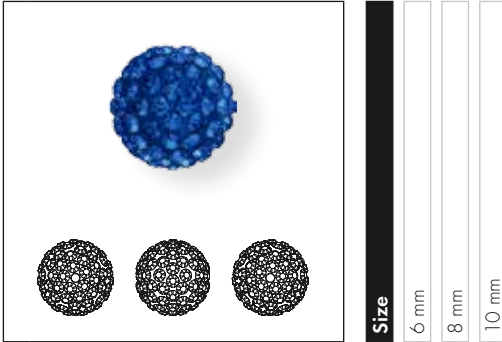

Colors		6 mm	8 mm	10 mm
<b>Plain Colors</b>				
Majestic Blue (296)	NEW!	■	■	■
Dark Sapphire (15)		■	■	■
<b>Color Effects</b>				
<b>Transparent Effects</b>				
Light Colorado Topaz Shimmer (246 971)	NEW!	■	■	■
Antique Gold (35)		■	■	■
Light Sapphire Shimmer (211 971)	NEW!	■	■	■
Cadetblue (43)		■	■	■
Light Siam Shimmer (227 971)	NEW!	■	■	■
Red 3 (21)		■	■	■

86 301 Half Hole Pavé Ball <sup>NEW!</sup>

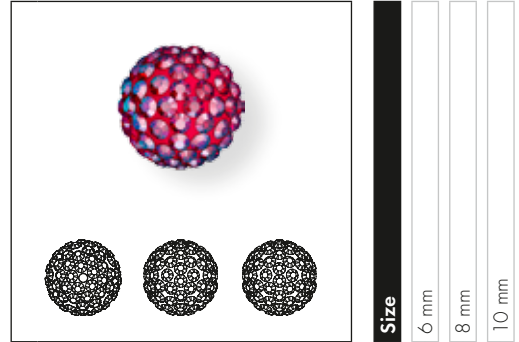

Crystal		6 mm	8 mm	10 mm
Crystal (001)		■	■	■
White (01)		■	■	■
<b>Colors</b>				
<b>Plain Colors</b>				
Amethyst (204)		■	■	■
Dark Lila (09)		■	■	■
Light Amethyst (212)		■	■	■
Mauve (14)		■	■	■
Light Rose (223)		■	■	■
Rose (06)		■	■	■
Majestic Blue (296)	NEW!	■	■	■
Dark Sapphire (15)		■	■	■
Montana (207)		■	■	■
Navy Blue (17)		■	■	■
Peridot (214)		■	■	■
Light Green (10)		■	■	■
Tanzanite (539)		■	■	■
Purple (08)		■	■	■
<b>Crystal Effects</b>				
<b>Transparent Effects</b>				
Crystal AB (001 AB)		■	■	■
White (01)		■	■	■
Crystal Golden Shadow (001 GSHA)		■	■	■
Pearl Silk (05)		■	■	■
<b>Color Effects</b>				
<b>Transparent Effects</b>				
Light Colorado Topaz Shimmer (246 971)		■	■	■
Antique Gold (35)		■	■	■
Light Sapphire Shimmer (211 971)		■	■	■
Cadetblue (43)		■	■	■
Light Siam Shimmer (227 971)		■	■	■
Red 3 (21)		■	■	■
<b>Metallic Effects</b>				
Jet Hematite (280 HEM)		■	■	■
Black (02)		■	■	■





A NEW CHAPTER  
THE BECHARMED & PAVÈ

# LETTER BEAD

Leading the global mega-trend for customization and individual style statements, Swarovski is launching its exciting BeCharmed Pavè Letter Beads on March 5, 2018.

The Beads (82201) designed to allow all kinds of sparkling messages and creative stories to be told through jewelry and beading across the fashion and DIY arenas. This is the first time that a BeCharmed Bead is available in a completely round version: each bead boasts the ultra-contemporary good looks of sleek, high-shine stainless steel with letters of the alphabet picked out with the high-octane dazzle of Xilion Chatons in a glamorous pavè setting. Running from "A" through to "Z," with the hashtag ("#") and ampersand ("&") symbols also available, they encourage the wearer to create an endless variety of words and statements in eye-catching style.

Infinitely versatile and with irresistible appeal, Letter Beads can be used singly as an attention-grabbing highlight, or arranged to form whole words in order to personalize jewelry, accessories and apparel. There are also myriad imaginative design possibilities when a sparkling message is conveyed in combination with other BeCharmed Beads and Charms. Indeed, the entire kaleidoscope of the Swarovski assortment will also mix brilliantly with these glittering letters.

The Letter Beads are suitable for hand sewing and numerous hand-application techniques, and they can be easily threaded onto metal chain, leather or nylon cord via a standard 4.5mm hole. Furthermore, in order to ensure maximum flexibility when it comes to application, each letter or symbol is picked out in crystals three times so that the perfectly round 12mm-diameter bead – the first time this size has been offered – is completely encircled.

82 201 Letter Bead <sup>NEW!</sup>



**Size**  
12x11 mm Stainless Steel

**Letter**

- A
- B
- C
- D
- E
- F
- G
- H
- I
- J
- K
- L
- M
- N
- O
- P
- Q
- R
- S
- T
- U
- V
- W
- X
- Y
- Z
- #
- &

# CRYSTAL PEARLS

**5810** Crystal Round Pearl

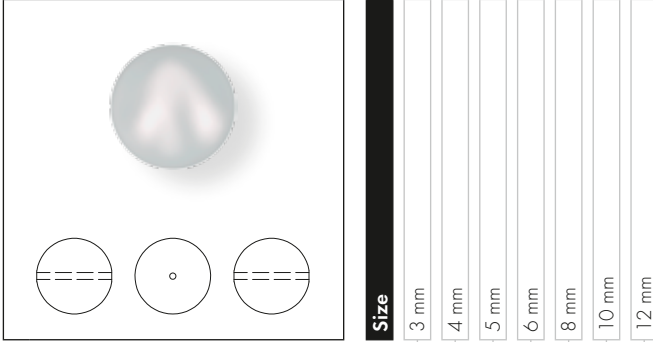

**Colors**

Crystal Iridescent Dove Grey Pearl (001 954) **NEW!**

**5817**

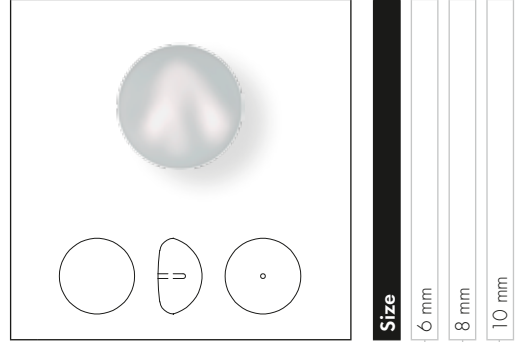

**Colors**

Crystal Iridescent Dove Grey Pearl (001 954) **NEW!**

**5818**

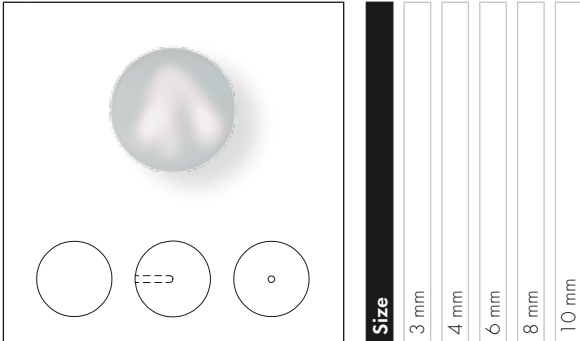

**Colors**

Crystal Iridescent Dove Grey Pearl (001 954) **NEW!**

**5860** Crystal Coin Pearl

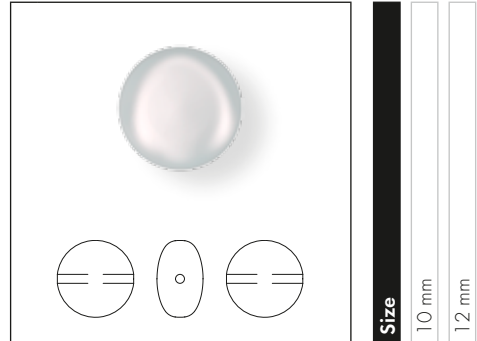

**Colors**

Crystal Iridescent Dove Grey Pearl (001 954) **NEW!**



# PENDANTS

6000

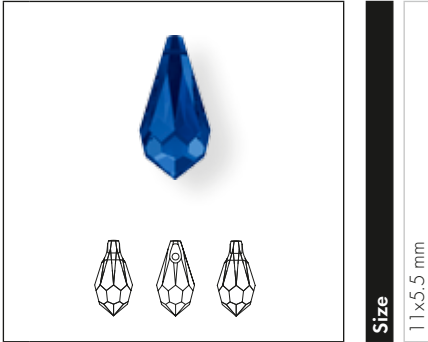

Size

11x5.5 mm

Colors

Plain Colors

● Majestic Blue (296)

NEW!

6106 Pear-shaped Pendant

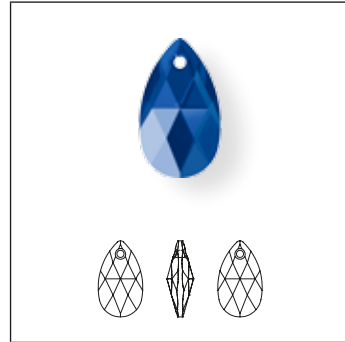

Size

16 mm

22 mm

Colors

Plain Colors

● Majestic Blue (296)

NEW!

6228 XILION Heart Pendant

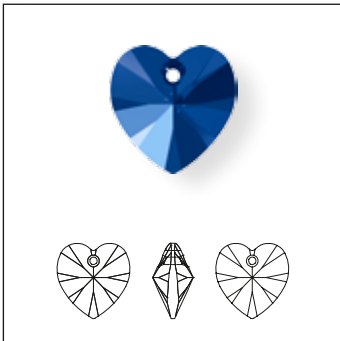

Size

10.3x10 mm

14.4x14 mm

18x17.5 mm

Colors

Plain Colors

● Majestic Blue (296)

NEW!

6428 XILION Pendant

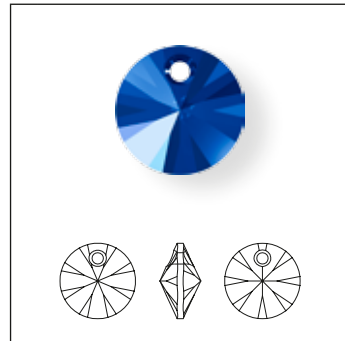

Size

8 mm

Colors

Plain Colors

● Majestic Blue (296)

NEW!

**6430** Classic Cut Pendant <sup>NEW!</sup>

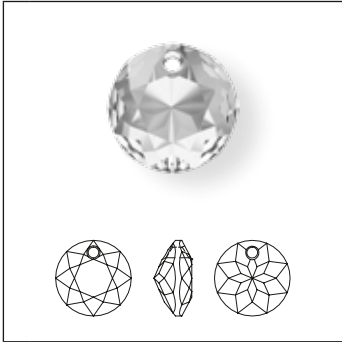

Size
8 mm
10 mm
14 mm

**Crystal**

Crystal (001)

**Colors**

**Plain Colors**

Amethyst (204)

Aquamarine (202)

Emerald (205)

Light Amethyst (212)

Light Siam (227)

Montana (207)

Peridot (214)

Rose (209)

Sapphire (206)

Siam (208)

Topaz (203)

**Crystal Effects**

**Transparent Effects**

Crystal AB (001 AB)

Crystal Bermuda Blue P (001 BBL)<sup>1</sup>

Crystal Golden Shadow (001 GSHA)

Crystal Silver Night (001 SINI)

Crystal Vitrail Medium P (001 VM)<sup>1</sup>

<sup>1</sup> For details about the protective coating, please refer to the Collection 2016 chapter 'Basic Information'.

# FLAT BACKS NO HOTFIX

## 2058 XILION Rose Enhanced

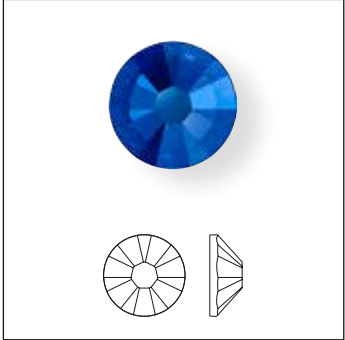

<b>Size</b>	SS 5	SS 7	SS 9
<b>Colors</b>			
<b>Plain Colors</b>			
● Majestic Blue F (296)	NEW!		

## 2088 XIRIUS Rose

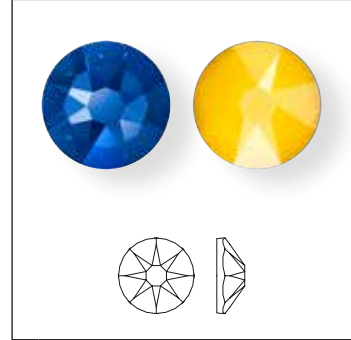

<b>Size</b>	SS 12	SS 16	SS 20	SS 30	SS 34
<b>Colors</b>					
<b>Plain Colors</b>					
● Majestic Blue F (296)	NEW!				
<b>Crystal Effects</b>					
<b>Crystal Laquer<sup>PRO</sup></b>					
● Crystal Buttercup (001 L124S)	NEW!				
● Crystal Lilac (001 L126S)	NEW!				
● Crystal Lime (001 L125S)	NEW!				



MINI SIZE FLAT BACKS

2200 Navette Flat Back

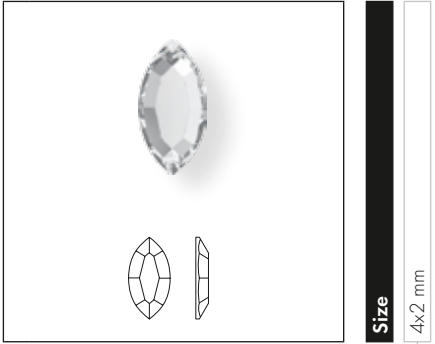

- Crystal**
- Crystal F (001)
- Colors**
- Plain Colors**
- Jet (280)
- Crystal Effects**
- Transparent Effects**
- Crystal AB F (001 AB)
- Crystal Golden Shadow F (001 GSHA)

2400 Square Flat Back

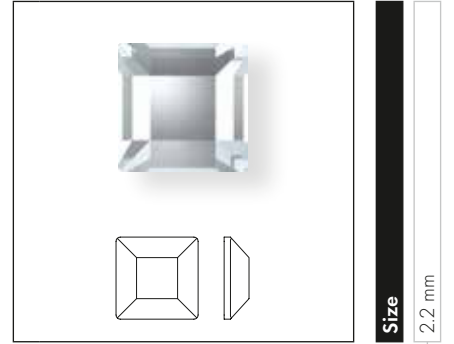

- Crystal**
- Crystal F (001)
- Colors**
- Plain Colors**
- Jet (280)
- Crystal Effects**
- Transparent Effects**
- Crystal AB F (001 AB)
- Crystal Golden Shadow F (001 GSHA)

2711 Triangle Flat Back

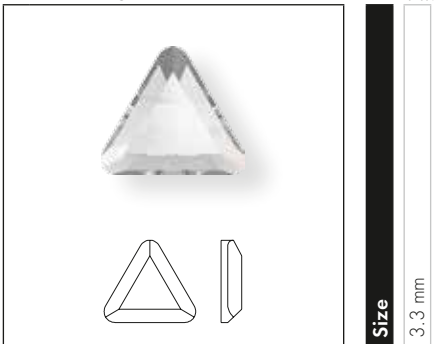

- Crystal**
- Crystal F (001)
- Colors**
- Plain Colors**
- Jet (280)
- Crystal Effects**
- Transparent Effects**
- Crystal AB F (001 AB)
- Crystal Golden Shadow F (001 GSHA)

GEOMETRIC FLAT BACKS

2771 Kite Flat Back <sup>NEW!</sup>

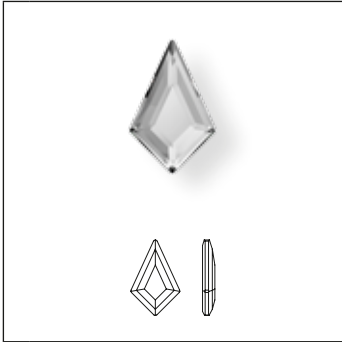

Size
6.4x4.2 mm
8.6x5.6 mm
12.9x8.3 mm

**Crystal**

Crystal F (001)

**Colors**

**Plain Colors**

Aquamarine F (202)

Black Diamond F (215)

Jet (280)

Light Rose F (223)

Light Siam F (227)

**Crystal Effects**

**Transparent Effects**

Crystal AB F (001 AB)

Crystal Golden Shadow F (001 GSHA)

Crystal Silver Shade F (001 SSHA)

**Color Effects**

**Metallic Effects**

Jet Hematite (280 HEM)

2772 Trapeze Flat Back <sup>NEW!</sup>

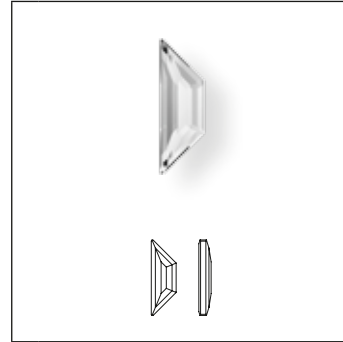

Size
6.5x2.1 mm
8.6x2.8 mm
12.9x4.2 mm

**Crystal**

Crystal F (001)

**Colors**

**Plain Colors**

Aquamarine F (202)

Black Diamond F (215)

Jet (280)

**Crystal Effects**

**Transparent Effects**

Crystal AB F (001 AB)

Crystal Golden Shadow F (001 GSHA)

Crystal Silver Shade F (001 SSHA)

**Color Effects**

**Metallic Effects**

Jet Hematite (280 HEM)

**2773** Diamond Shape Flat Back <sup>NEW!</sup>

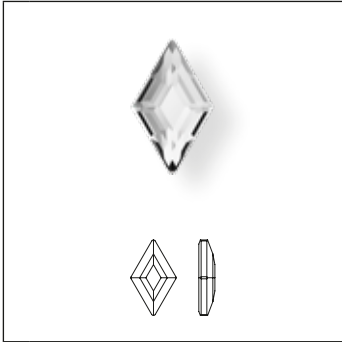

Size
5x3 mm
6.6x3.9 mm
9.9x5.9 mm

**Crystal**

Crystal F (001)

**Colors**

**Plain Colors**

Aquamarine F (202)

Black Diamond F (215)

Jet (280)

Light Rose F (223)

Light Siam F (227)

**Crystal Effects**

**Transparent Effects**

Crystal AB F (001 AB)

Crystal Golden Shadow F (001 GSHA)

Crystal Silver Shade F (001 SSHA)

**Color Effects**

**Metallic Effects**

Jet Hematite (280 HEM)

FLAT BACKS NO HOTFIX



# FLAT BACKS HOTFIX

## 2038 XILION Rose Hotfix

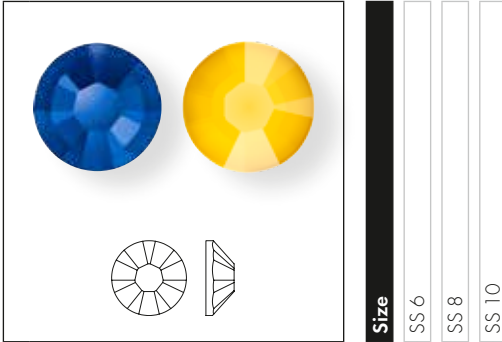

Colors		Size	SS 6	SS 8	SS 10
<b>Plain Colors</b>					
● Majestic Blue A HF (296)	NEW!		■	■	■
<b>Crystal Effects</b>					
<b>Crystal Laquer<sup>PRO</sup></b>					
● Crystal Buttercup HFT (001 L124S)	NEW!				■
● Crystal Lilac HFT (001 L126S)	NEW!				■
● Crystal Lime HFT (001 L125S)	NEW!				■

## 2078 XIRIUS Rose Hotfix

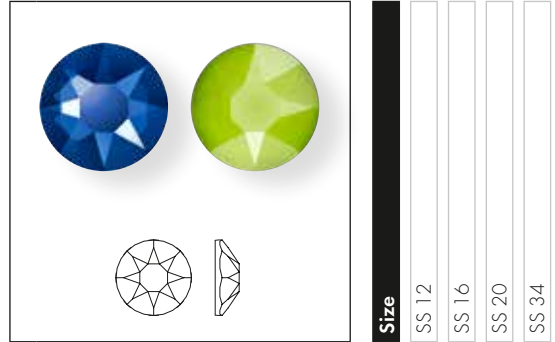

Colors		Size	SS 12	SS 16	SS 20	SS 34
<b>Plain Colors</b>						
● Majestic Blue A HF (296)	NEW!		■	■	■	■
<b>Crystal Effects</b>						
<b>Crystal Laquer<sup>PRO</sup></b>						
● Crystal Buttercup HFT (001 L124S)	NEW!					■
● Crystal Lilac HFT (001 L126S)	NEW!					■
● Crystal Lime HFT (001 L125S)	NEW!					■

**MINI SIZE FLAT BACKS**

**2200** Navette Flat Back Hotfix



- Crystal**
- Crystal M HF (001)
- Colors**
- Plain Colors**
- Jet M HF (280)
- Crystal Effects**
- Transparent Effects**
- Crystal AB M HF (001 AB)
- Crystal Golden Shadow M HF (001 GSHA)

**2400** Square Flat Back Hotfix

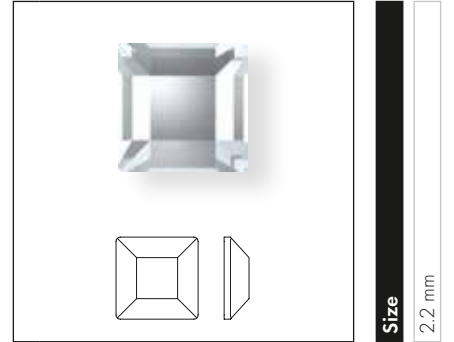

- Crystal**
- Crystal M HF (001)
- Colors**
- Plain Colors**
- Jet M HF (280)
- Crystal Effects**
- Transparent Effects**
- Crystal AB M HF (001 AB)
- Crystal Golden Shadow M HF (001 GSHA)

**2711** Triangle Flat Back Hotfix

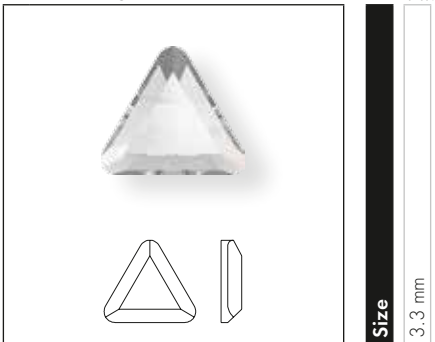

- Crystal**
- Crystal M HF (001)
- Colors**
- Plain Colors**
- Jet M HF (280)
- Crystal Effects**
- Transparent Effects**
- Crystal AB M HF (001 AB)
- Crystal Golden Shadow M HF (001 GSHA)

GEOMETRIC FLAT BACKS

2771 Kite Flat Back Hoflix <sup>NEW!</sup>

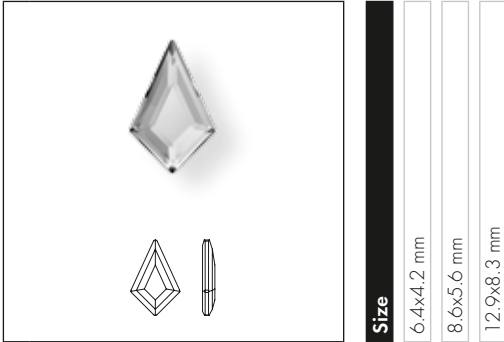

Crystal	6.4x4.2 mm	8.6x5.6 mm	12.9x8.3 mm
Crystal M HF (001)	■	■	■
<b>Colors</b>			
<b>Plain Colors</b>			
Aquamarine M HF (202)	■	■	■
Black Diamond M HF (215)	■	■	■
Jet M HF (280)	■	■	■
Light Rose M HF (223)	■	■	■
Light Siam M HF (227)	■	■	■
<b>Crystal Effects</b>			
<b>Transparent Effects</b>			
Crystal AB M HF (001 AB)	■	■	■
Crystal Golden Shadow M HF (001 GSHA)	■	■	■
Crystal Silver Shade M HF (001 SSHA)	■	■	■
<b>Color Effects</b>			
<b>Metallic Effects</b>			
Jet Hematite M HF (280 HEM)	■	■	■

2772 Trapeze Flat Back Hoflix <sup>NEW!</sup>

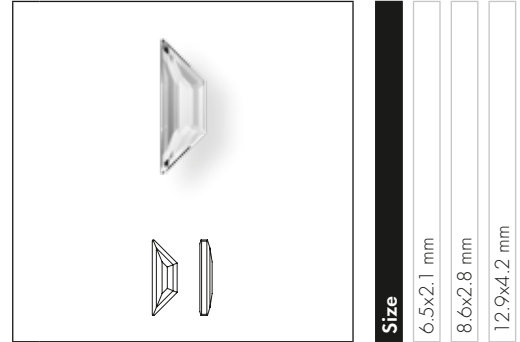

Crystal	6.5x2.1 mm	8.6x2.8 mm	12.9x4.2 mm
Crystal M HF (001)	■	■	■
<b>Colors</b>			
<b>Plain Colors</b>			
Aquamarine M HF (202)	■	■	■
Black Diamond M HF (215)	■	■	■
Jet M HF (280)	■	■	■
<b>Crystal Effects</b>			
<b>Transparent Effects</b>			
Crystal AB M HF (001 AB)	■	■	■
Crystal Golden Shadow M HF (001 GSHA)	■	■	■
Crystal Silver Shade M HF (001 SSHA)	■	■	■
<b>Color Effects</b>			
<b>Metallic Effects</b>			
Jet Hematite M HF (280 HEM)	■	■	■

**2773** Diamond Shape Flat Back Hotfix <sup>NEW!</sup>

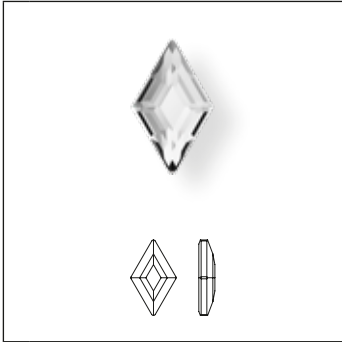

Size
5x3 mm
6.6x3.9 mm
9.9x5.9 mm

**Crystal**

Crystal M HF (001)

**Colors**

**Plain Colors**

Aquamarine M HF (202)

Black Diamond M HF (215)

Jet M HF (280)

Light Rose M HF (223)

Light Siam M HF (227)

**Crystal Effects**

**Transparent Effects**

Crystal AB M HF (001 AB)

Crystal Golden Shadow M HF (001 GSHA)

Crystal Silver Shade M HF (001 SSHA)

**Color Effects**

**Metallic Effects**

Jet Hematite M HF (280 HEM)

FLAT BACKS HOTFIX



---

**Application Advice**

The Navette/Square and Triangle Flat Back Hotfix can be easily applied using a standard heat press.

The application parameters for Creation Stones apply.

The Kite/Trapeze and Diamond Shape Flat Back Hotfix can be easily applied using a standard heat press.

For articles smaller than 8 mm in diameter, the application parameters for Creation Stones apply. For bigger sizes, the application parameters are the same as those that apply to Creation Stones Plus. These items are not suitable for application from the front.

---

**Care Instructions**

The care instructions for the Navette/Square and Triangle Flat Back Hotfix are the same as those that apply to Creation Stones from the Flat Back Hotfix assortment.

The care instructions for the Kite/Trapeze and Diamond Shape Flat Back Hotfix are the same as those that apply to Creation Stones Plus from the Flat Back Hotfix assortment. For articles smaller than 8 mm in diameter, the care instructions for Creation Stones apply.

---

For detailed information, please refer to the Application Manual and our business website [SWAROVSKI-PROFESSIONAL.COM](http://SWAROVSKI-PROFESSIONAL.COM)

# SEW-ON ARTICLES

## EMERALD CUT SEW-ON STONE

**3252** Emerald Cut Sew-on Stone <sup>NEW!</sup>



Size	14x10 mm	20x14 mm	28x20 mm
------	----------	----------	----------

**Crystal**

Crystal F (001)

**Colors**

**Plain Colors**

Aquamarine F (202)

Emerald F (205)

Graphite F (253)

Jet (280)

Majestic Blue F (296) <sup>NEW!</sup>

Scarlet F (276)

Sunflower F (292)

Vintage Rose F (319)

**Crystal Effects**

**Transparent Effects**

Crystal AB F (001 AB)

Crystal Golden Shadow F (001 GSHA)

Crystal Silver Shade F (001 SSHA)

SEW-ON ARTICLES

### Application Advice

The Emerald Cut Sew-on Stone can be either sewn on or applied to different fabrics by hand. When processing the 28 mm version, a thread with a thread count greater than Nm 50 is recommended.

### Care Instructions

Due to the size of this article (especially the 28 mm version) washing it by hand is recommended in order to avoid detaching the fabric and to prevent the crystals from being scratched:



Turn inside out and use mild laundry detergent (wash by hand, max. temp. 30°C, very mild process).

Do not use chlorine bleach!

Do not tumble dry!

Do not iron!

The textile can be gently dry-cleaned using perchloroethylene. Turn inside out.

The textile can be gently dry-cleaned using hydrocarbon. Turn inside out.

The textile will withstand gentle professional wet cleaning. Turn inside out.

To protect the crystals as much as possible, the use of a soft wash bag is recommended.

For detailed information about sewing, please refer to the Application Manual and our business website [SWAROVSKI-PROFESSIONAL.COM](http://SWAROVSKI-PROFESSIONAL.COM)

**CRYSTAL ELEMENTS**

<b>Article Size</b>	<b>Packing Unit = Minimum Order Quantity in Pieces</b>	<b>Average Net Weight in Gram per Packing Unit Crystal (001)</b>	<b>Average Gross Weight in Gram per Packing Unit Crystal (001)</b>
<b>4322</b>			
10x5 mm	72	13.95	33.93
14x7 mm	48	22.56	43.16
18x9 mm	24	24.72	45.45
22x11 mm	15	30.00	54.73
30x15 mm	12	54.00	74.10
<b>5060</b>			
5.5 mm	288	49.40	62.92
7.5 mm	144	48.82	72.67
<b>5061</b>			
5.5 mm	288	62.65	75.50
7.5 mm	144	46.37	71.85
<b>5062</b>			
5.5 mm	288	50.85	67.95
7.5 mm	144	40.32	62.16
<b>5950</b>			
15 mm	10	12.00	12.01
30 mm	10	18.60	18.61
<b>5951</b>			
15 mm	10	6.80	6.81
30 mm	10	13.90	13.91
<b>82 201</b>			
12x11 mm	12	46.2	66.00
<b>86 301</b>			
6 mm	12	3.50	23.00
8 mm	12	7.80	27.30
10 mm	12	14.50	34.00
<b>6430</b>			
8 mm	72	23.70	42.12
10 mm	48	31.68	51.86
14 mm	24	40.90	61.63

PRODUCT DETAILS



<b>Article Size</b>	<b>Packing Unit = Minimum Order Quantity in Pieces</b>	<b>Average Net Weight in Gram per Packing Unit Crystal (001)</b>	<b>Average Gross Weight in Gram per Packing Unit Crystal (001)</b>
<b>2771</b>			
6.4x4.2 mm	288	9.04	17.87
8.6x5.6 mm	216	16.84	43.02
12.9x8.3 mm	144	36.29	61.39
<b>2772</b>			
6.5x2.1 mm	288	6.39	15.17
8.6x2.8 mm	288	16.29	40.71
12.9x4.2 mm	144	25.57	53.86
<b>2773</b>			
5x3 mm	288	4.83	13.66
6.6x3.9 mm	288	11.23	35.65
9.9x5.9 mm	144	19.30	43.39
<b>3252</b>			
14x10 mm	36	29.59	50.19
20x14 mm	15	35.55	60.28
28x20 mm	10	67.65	88.78

# TRANSFERS

---

**New Exclusive Color for art. 2038 XILION Rose and art. 2078 XIRIUS Rose**

**Available in the following sizes:**

---

Majestic Blue (296)

**2038 XILION Rose** SS 6, SS 8, SS 10  
**2078 XIRIUS Rose** SS 12, SS 16, SS 20, SS 34

---

**New Exclusive Crystal Shiny Lacquer<sup>PRO</sup> for art. 2038 XILION Rose and art. 2078 XIRIUS Rose**

**Available in the following sizes:**

---

Crystal Buttercup (001 L124S)  
 Crystal Lilac (001 L126S)  
 Crystal Lime (001 L125S)

**2038 XILION Rose** SS 10  
**2078 XIRIUS Rose** SS 16, SS 34

MINI SIZE FLAT BACKS

2200 Navette Flat Back

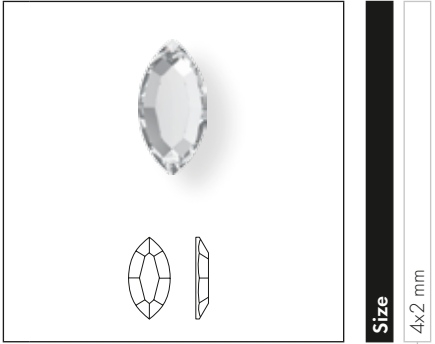

- Crystal**
- Crystal M HF (001)
- Colors**
- Plain Colors**
- Jet M HF (280)
- Crystal Effects**
- Transparent Effects**
- Crystal AB M HF (001 AB)
- Crystal Golden Shadow M HF (001 GSHA)

2400 Square Flat Back

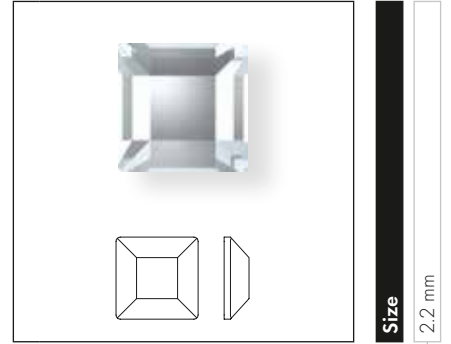

- Crystal**
- Crystal M HF (001)
- Colors**
- Plain Colors**
- Jet M HF (280)
- Crystal Effects**
- Transparent Effects**
- Crystal AB M HF (001 AB)
- Crystal Golden Shadow M HF (001 GSHA)

2711 Triangle Flat Back

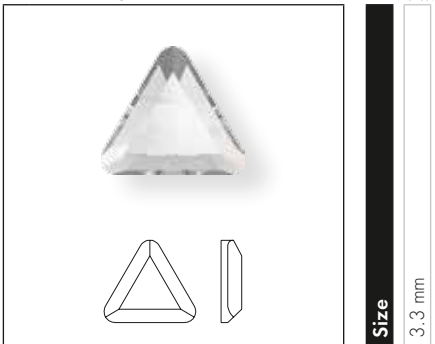

- Crystal**
- Crystal M HF (001)
- Colors**
- Plain Colors**
- Jet M HF (280)
- Crystal Effects**
- Transparent Effects**
- Crystal AB M HF (001 AB)
- Crystal Golden Shadow M HF (001 GSHA)

GEOMETRIC FLAT BACKS

2771 Kite Flat Back <sup>NEW!</sup>

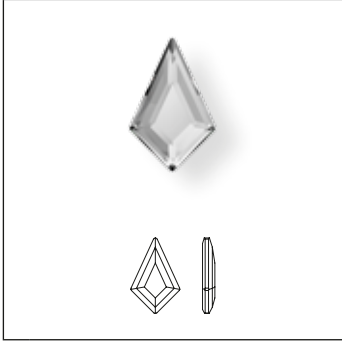

<b>Size</b>	6.4x4.2 mm	8.6x5.6 mm	12.9x8.3 mm
-------------	------------	------------	-------------

**Crystal**

Crystal M HF (001)

**Colors**

**Plain Colors**

Aquamarine M HF (202)

Black Diamond M HF (215)

Jet M HF (280)

Light Rose M HF (223)

Light Siam M HF (227)

**Crystal Effects**

**Transparent Effects**

Crystal AB M HF (001 AB)

Crystal Golden Shadow M HF (001 GSHA)

Crystal Silver Shade M HF (001 SSHA)

**Color Effects**

**Metallic Effects**

Jet Hematite M HF (280 HEM)

2772 Trapeze Flat Back <sup>NEW!</sup>

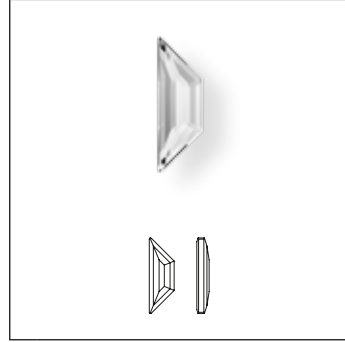

<b>Size</b>	6.5x2.1 mm	8.6x2.8 mm	12.9x4.2 mm
-------------	------------	------------	-------------

**Crystal**

Crystal M HF (001)

**Colors**

**Plain Colors**

Aquamarine M HF (202)

Black Diamond M HF (215)

Jet M HF (280)

**Crystal Effects**

**Transparent Effects**

Crystal AB M HF (001 AB)

Crystal Golden Shadow M HF (001 GSHA)

Crystal Silver Shade M HF (001 SSHA)

**Color Effects**

**Metallic Effects**

Jet Hematite M HF (280 HEM)

TRANSFERS



**2773** Diamond Shape Flat Back <sup>NEW!</sup>

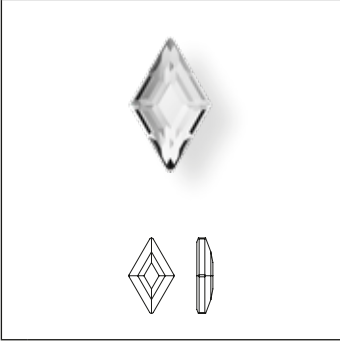

Size	5x3 mm	6.6x3.9 mm	9.9x5.9 mm
------	--------	------------	------------

**Crystal**

Crystal M HF (001)

**Colors**

**Plain Colors**

Aquamarine M HF (202)

Black Diamond M HF (215)

Jet M HF (280)

Light Rose M HF (223)

Light Siam M HF (227)

**Crystal Effects**

**Transparent Effects**

Crystal AB M HF (001 AB)

Crystal Golden Shadow M HF (001 GSHA)

Crystal Silver Shade M HF (001 SSHA)

**Color Effects**

**Metallic Effects**

Jet Hematite M HF (280 HEM)

---

**Application Advice**

The Navette/Square and Triangle Flat Back Hotfix can be easily applied using a standard heat press.

The application parameters for Creation Stones apply.

The Kite/Trapeze and Diamond Shape Flat Back Hotfix can be easily applied using a standard heat press.

For articles smaller than 8 mm in diameter, the application parameters for Creation Stones apply. For bigger sizes, the application parameters are the same as those that apply to Creation Stones Plus. These items are not suitable for application from the front.

---

**Care Instructions**

The care instructions for the Navette/Square and Triangle Flat Back Hotfix are the same as those that apply to Creation Stones from the Flat Back Hotfix assortment.

The care instructions for the Kite/Trapeze and Diamond Shape Flat Back Hotfix are the same as those that apply to Creation Stones Plus from the Flat Back Hotfix assortment. For articles smaller than 8 mm in diameter, the care instructions for Creation Stones apply.

---

For detailed information, please refer to the Application Manual and our business website [SWAROVSKI-PROFESSIONAL.COM](http://SWAROVSKI-PROFESSIONAL.COM)

## STANDARD COLLECTION

13 368

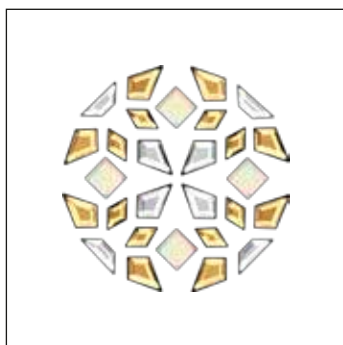

**C** 001AB/001GSHA/001/001/  
001GSHA

**E** 2402MM4/2771MM6,4X4,2/  
2771MM6,4X4,2/2772MM6,5X2,1/  
2773MM5X3

**S** ~30x30

**M** 110 PCS **100%**

13 369

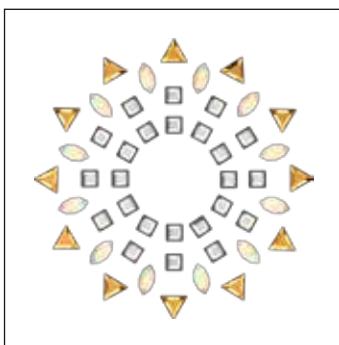

**C** 001AB/001/001GSHA

**E** 2200MM4X2/2400MM2/  
2711MM3,3

**S** ~37x37

**M** 76 PCS **100%**

13 370

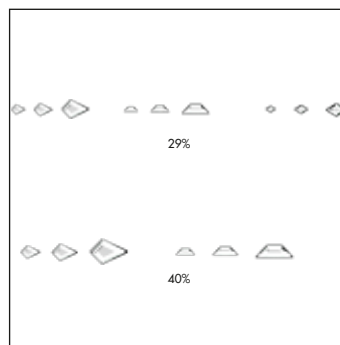

**C** 001/001/001/001/001/001/  
001/001/001

**E** 2771MM6,4X4,2/2771MM8,6X5,6/  
2771MM12,9X8,3/2772MM6,5X2,1/  
2772MM8,6X2,8/2772MM12,9X4,2/  
2773MM5X3/2773MM6,6X3,9/  
2773MM9,9X5,9

**S** ~153x8

**M** 50 PCS

13 371

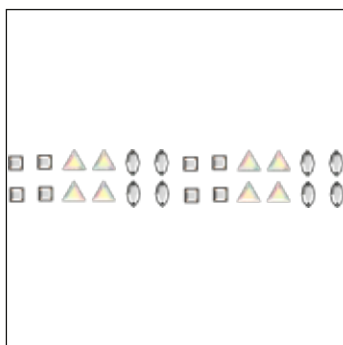

**C** 001/001/001AB

**E** 2200MM4X2/2400MM2/  
2711MM3,3

**S** ~56x9

**M** 126 PCS **79%**

13 373

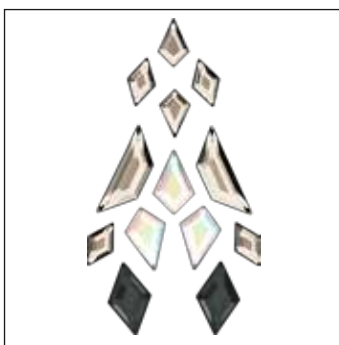

**C** 001SSHA/001AB/001SSHA/  
001SSHA/215

**E** 2771MM6,4x4,2/2771MM8,6x5,6/  
2772MM12,9x4,2/2773MM6,6x3,9/  
2773MM9,9x5,9

**S** ~23x41

**M** 104 PCS **100%**

CRYSTAL INSPIRATIONS COLLECTION

Leisure

13 356

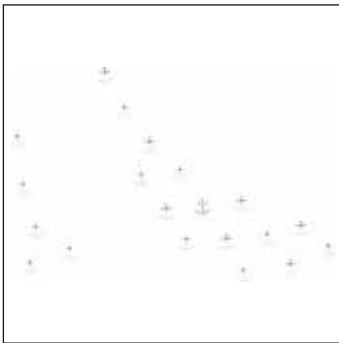

C R9003-001/296  
 E M2-S6/S6  
 S ~226x149  
 M 5 PCS **19%**

13 360



C 001/001/001/202/001  
 E 2602MM14X10/2771MM6.4X4.2  
 /2771MM8.6X5.6/2771MM12.9X  
 8.3/2771MM12.9X8.3  
 S ~164x30  
 M 25 PCS **27%**

Adventure

13 357

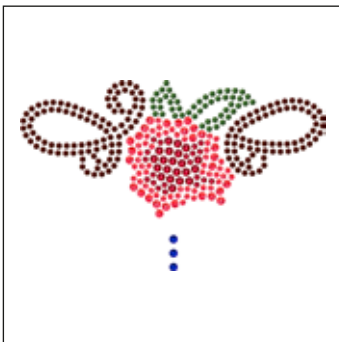

C R8012/R6025-542/276/542/  
 276/296  
 E M2/M2-S6/S6/S10/S10/S10  
 S ~101x63  
 M 12 PCS **40%**

13 358

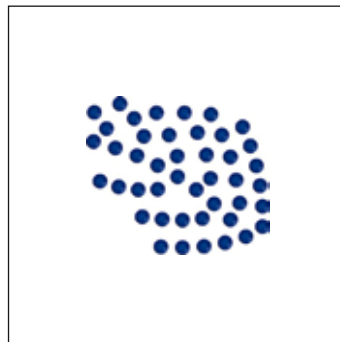

C 296  
 E S6  
 S ~24x21  
 M 210 PCS **100%**

13 359

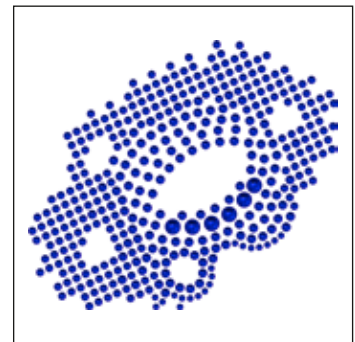

C 296/296/296/296  
 E S6/S8/S10/S20  
 S ~91x79  
 M 12 PCS **45%**



Freedom

13 355

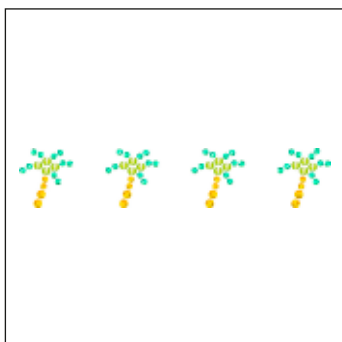

<b>C</b>	001L115S/226/001L125S/226
<b>E</b>	S10/S10/S16/S16
<b>S</b>	~137x26
<b>M</b>	15 PCS <b>30%</b>

Day Cocktail Wear

13 361

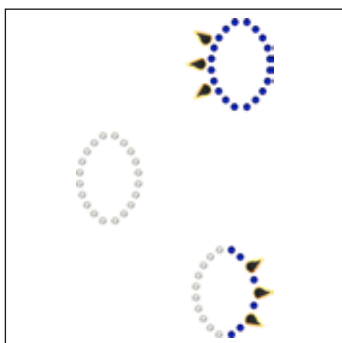

<b>C</b>	280DORZ/001DORZ/296
<b>E</b>	CS8X5/S10/S10
<b>S</b>	~74x120
<b>M</b>	18 PCS <b>35%</b>

13 362

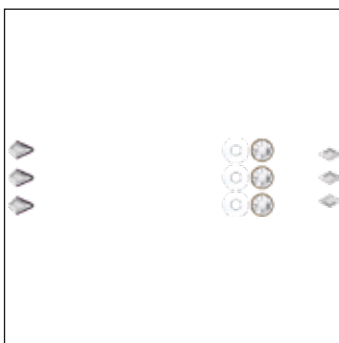

<b>C</b>	R9003-001DORZ/001/001
<b>E</b>	M8-S34/2771MM8.6X5.6/ 2773MM6.6X3.9
<b>S</b>	~104x25
<b>M</b>	40 PCS <b>42%</b>

13 363

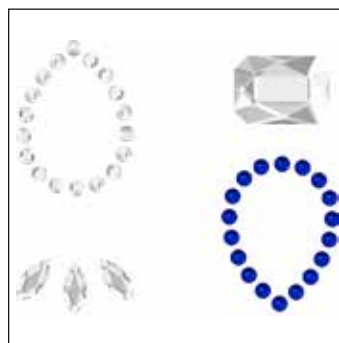

<b>C</b>	296/001/001/001
<b>E</b>	S8/S8/2201MM8X3.5/ 2602MM14X10
<b>S</b>	~48X40
<b>M</b>	64 PCS <b>90%</b>

Beach Wear

13 364

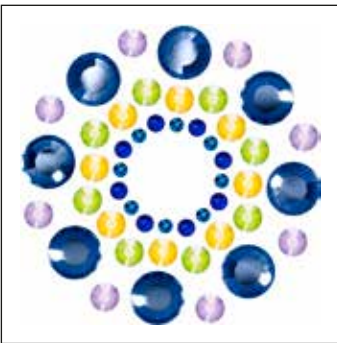

<b>C</b>	369SHIM/296/001L124S/ 001L126S/001L125S/001L110S
<b>E</b>	S6/S8/S16/S16/S16/S34
<b>S</b>	~40x40
<b>M</b>	68 PCS <b>100%</b>

Leather

13 365

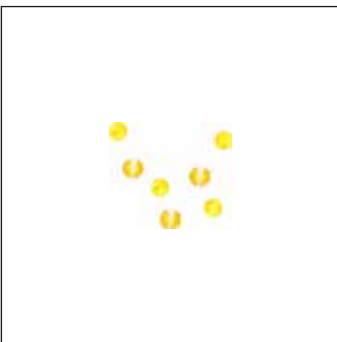

<b>C</b>	231/001L124S
<b>E</b>	S8/S10
<b>S</b>	~16x14
<b>M</b>	342 PCS <b>100%</b>

13 366

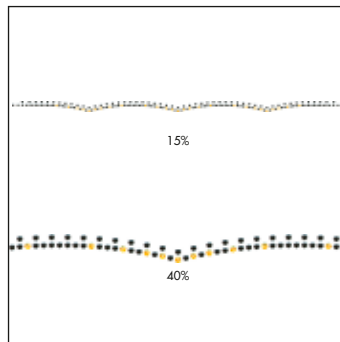

<b>C</b>	096-001METSH
<b>E</b>	M2-S6
<b>S</b>	~292x9
<b>M</b>	12 PCS

13 367

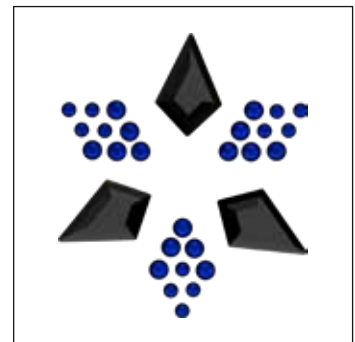

<b>C</b>	296/296/280HEM
<b>E</b>	S6/S8/2771MM12.9X8.3
<b>S</b>	~33x37
<b>M</b>	84 PCS <b>100%</b>

# SYNTHETICS

---

## CRYSTAL FABRIC – MOTIFS

---

Crystal Inspirations Collection – Freedom

57 388



**C** GP15034 022 001 CAL

**S** ~57x57

**M** 56 PCS

**70%**

---

## CRYSTAL GALUCHAT

---

### New Effect for Crystal Galuchat

89 800-89 899

Color of Film  
012 Black

Color Effects

Metallic Effects

● Jet Hematite (280 HEM) **NEW!**

Detailed description: This block contains a large white square with the number '89 800-89 899' in the center. To its right is a vertical bar with a black top section labeled 'Color of Film' and a white bottom section labeled '012 Black'. Below the main square are three horizontal bars: a black bar labeled 'Color Effects', a grey bar labeled 'Metallic Effects', and a white bar with a black circle icon labeled 'Jet Hematite (280 HEM)'. A small black square with the word 'NEW!' is positioned to the right of the 'Jet Hematite' bar.

SYNTHETICS

---

### Overview of available Effect

Jet Hematite (280 HEM)

012 Black

Detailed description: This block shows a vertical rectangular panel. The central portion is black and filled with numerous small, bright white, irregularly shaped particles, representing the 'Jet Hematite (280 HEM)' effect. The panel is flanked by white borders on the left and right. Below the panel, the text '012 Black' is centered.



---

**CRYSTAL GALUCHAT - MOTIFS**

---

**Standard Collection**

**89 819**

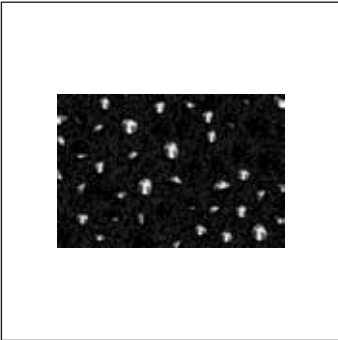

<b>C</b>	012 280HEM 280HEM 280HEM
<b>S</b>	~30x20
<b>M</b>	110 PCS <b>100%</b>

---

## CRYSTAL MEDLEY

---

### New Effect for Crystal Medley

<p><b>73 000</b> onwards</p>	<p><b>Color of Film</b> 012 Black</p>
<p><b>Color Effects</b></p>	
<p><b>Metallic Effects</b></p>	
<p>● Jet Nut (280 NUT)</p>	<p><b>NEW!</b></p>

SYNTHETICS

---

### Overview of available Effect

Jet Nut (280 NUT)



012 Black

---

**CRYSTAL MEDLEY - MOTIFS**

---

**Standard Collection**

**73 000**

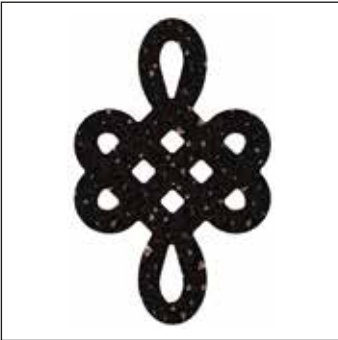

<b>C</b>	012 280NUT 280NUT 280 NUT
<b>S</b>	~80x126
<b>M</b>	9 PCS <b>33%</b>

# METAL TRIMMINGS

## FLAT BACK BANDINGS

55 000



R 001-024  
 SS SS 20  
 M 05 M **100%**

55 001<sup>1</sup>

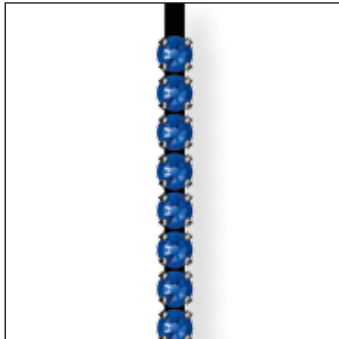

R 001  
 SS SS 20  
 M 10 M **100%**

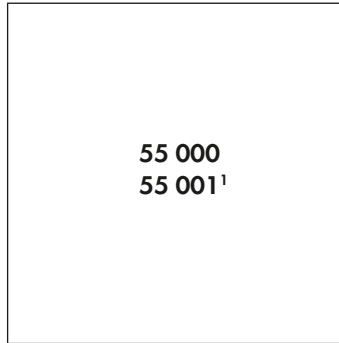

Color of Thread / Net-edge	Color of Casing
012 / 112 / 212 Black	081 Gold
022 / 122 / 222 White	082 Silver
	086 Gun Metal
	093 Rose Gold
	088 Stainless Steel

**Colors**

**Plain Colors**

● Majestic Blue F (296)

**Crystal Effects**

**Crystal Laquer<sup>PRO</sup>**

● Crystal Buttercup (001 L124S)

● Crystal Lilac (001 L126S)

● Crystal Lime (001 L125S)

NEW!	■	■	■	■	■	■	■
NEW!	■	■	■	■	■	■	■
NEW!	■	■	■	■	■	■	■

METAL TRIMMINGS

<sup>1</sup> Art. 55 001 is not available with net-edge. When ordering one row with net-edge, art. 55 000 should be used.



55 300

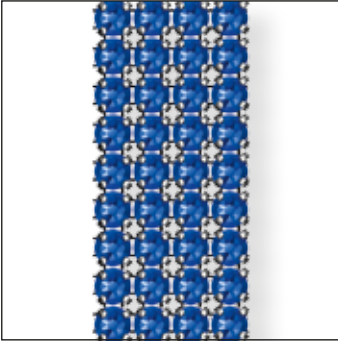

R 001-024  
 SS SS 16  
 M 05 M **100%**

55 301<sup>1</sup>

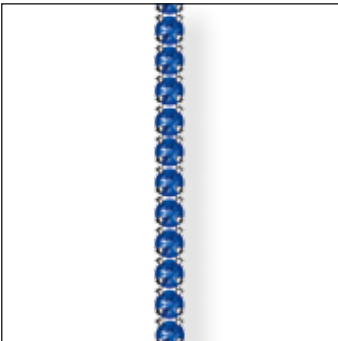

R 001  
 SS SS 16  
 M 05 M **100%**

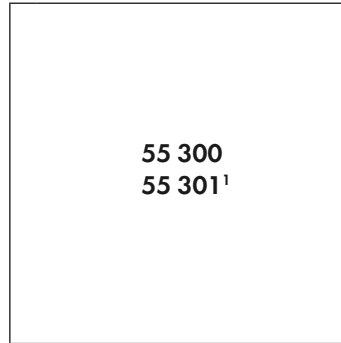

**Colors**

**Plain Colors**

● Majestic Blue F (296) **NEW!**

**Crystal Effects**

**Crystal Laquer<sup>PRO</sup>**

● Crystal Buttercup (001 L124S) **NEW!**

● Crystal Lilac (001 L126S) **NEW!**

● Crystal Lime (001 L125S) **NEW!**

Color of Thread / Net-edge	Color of Casing
012 / 112 / 212 Black	081 Gold
022 / 122 / 222 White	082 Silver
	086 Gun Metal
	093 Rose Gold

NEW!	■	■	■	■	■	■
NEW!	■	■	■	■	■	■
NEW!	■	■	■	■	■	■
NEW!	■	■	■	■	■	■

<sup>1</sup> Art. 55 301 is not available with net-edge. When ordering one row with net-edge, art. 55 300 should be used.

55 500

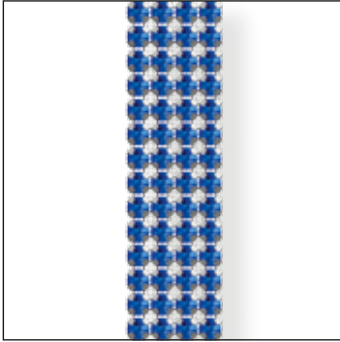

R 001-024  
 SS SS 12  
 M 10 M **100%**

55 501<sup>1</sup>

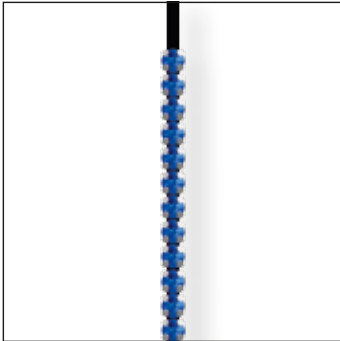

R 001  
 SS SS 12  
 M 10 M **100%**

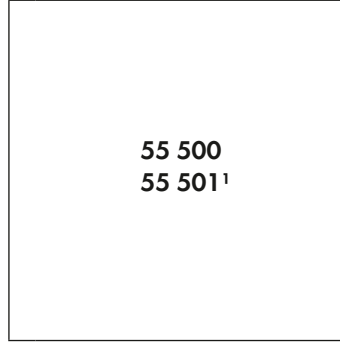

- Colors**
- Plain Colors**
- Majestic Blue F (296)
- Crystal Effects**
- Crystal Laquer<sup>PRO</sup>**
- Crystal Buttercup (001 L124S)
- Crystal Lilac (001 L126S)
- Crystal Lime (001 L125S)

Color of Thread / Net-edge	Color of Casing
012 / 112 / 212 Black	081 Gold
022 / 122 / 222 White	082 Silver
	086 Gun Metal
	093 Rose Gold

NEW!	<input type="checkbox"/>	<input type="checkbox"/>	<input type="checkbox"/>	<input type="checkbox"/>	<input type="checkbox"/>	<input type="checkbox"/>
NEW!	<input type="checkbox"/>	<input type="checkbox"/>	<input type="checkbox"/>	<input type="checkbox"/>	<input type="checkbox"/>	<input type="checkbox"/>
NEW!	<input type="checkbox"/>	<input type="checkbox"/>	<input type="checkbox"/>	<input type="checkbox"/>	<input type="checkbox"/>	<input type="checkbox"/>

<sup>1</sup> Art. 55 501 is not available with net-edge. When ordering one row with net-edge, art. 55 500 should be used.



METAL COMPONENTS – RIVETS

53 001 Rivets

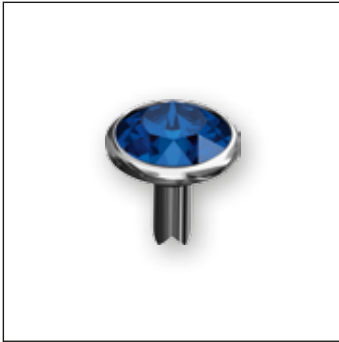

SS SS 29  
M 500 PCS 250%

53 005 Rivets



SS SS 34  
M 500 PCS 250%

53 006 Rivets



SS SS 39  
M 300 PCS 250%

53 008 Rivets

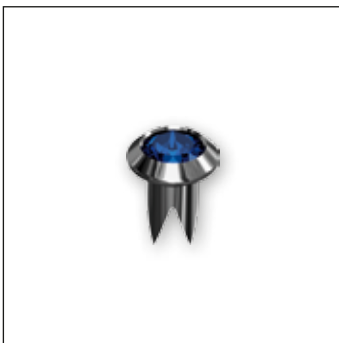

SS PP 24  
M 500 PCS 250%

53 001 <sup>1</sup>  
53 005 <sup>1</sup>  
53 006 <sup>1</sup>  
53 008 <sup>1/2</sup>

Colors

Plain Colors

● Majestic Blue F [296] NEW!

**Color of Casing**

- 081 Gold
- 082 Silver
- 086 Gun Metal
- 088 Stainless Steel
- 093 Rose Gold

Overview of all available Colors of Casing

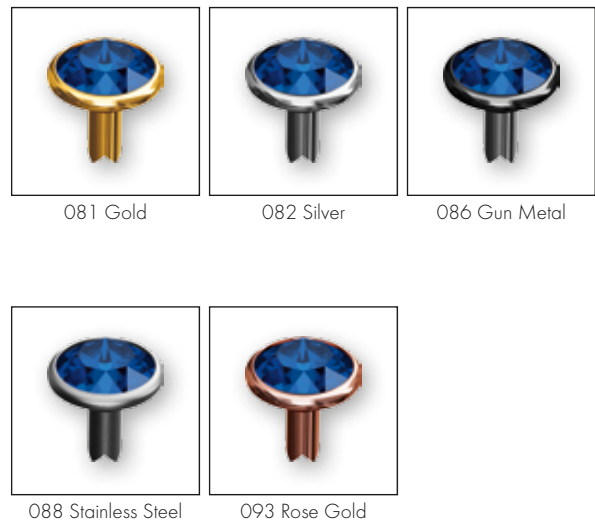

<sup>1</sup> For respective Back Parts please refer to the chapter "Metal Trimmings" (page 676) in Crystal Collection 2016

<sup>2</sup> Art. 53 008 is only available in stainless steel.

METAL COMPONENTS – ROSES MONTÉES

53 100 Rose Montées



SS SS 12  
M 1,440 PCS 250%

53 102 Rose Montées



SS SS 16  
M 1,440 PCS 250%

53 103 Rose Montées

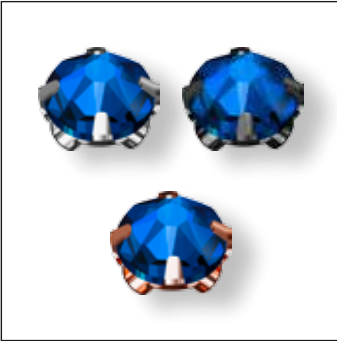

SS SS 30  
M 720 PCS 250%

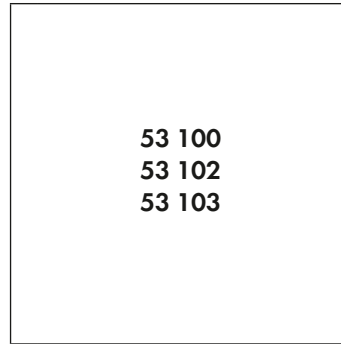

Color of Casing	
082 Silver	
086 Gun Metal	
093 Rose Gold	

Colors

Plain Colors

● Majestic Blue F [296]

NEW! ■ ■ ■



METAL COMPONENTS – ROSE PINS

53 301 Rose Pins

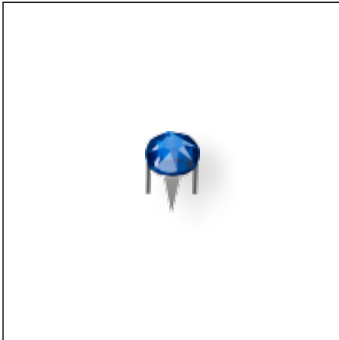

SS SS 10  
M 1,440 PCS 250%

53 302 Rose Pins

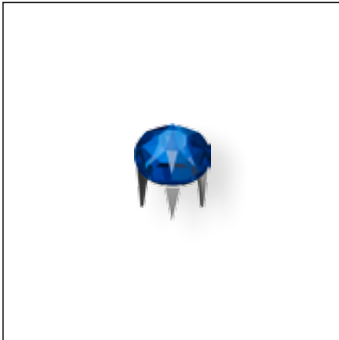

SS SS 16  
M 1,440 PCS 250%

53 303 Rose Pins



SS SS 20  
M 720 PCS 250%

53 304 Rose Pins



SS SS 34  
M 288 PCS 250%

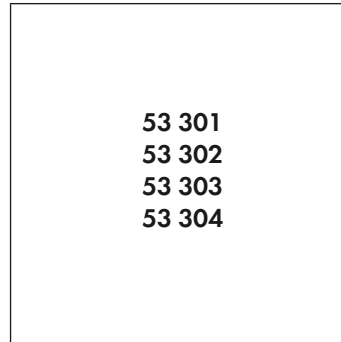

Color of Casing  
088 Stainless Steel

Colors

Plain Colors

● Majestic Blue F [296]

NEW!

METAL COMPONENTS – 3D STUDS

54 001 3D Studs 4 mm

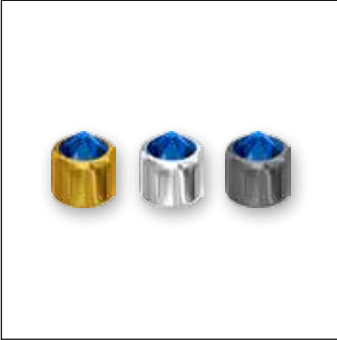

SS SS 16  
 M 1000 PCS **250%**

54 002 3D Studs 6 mm

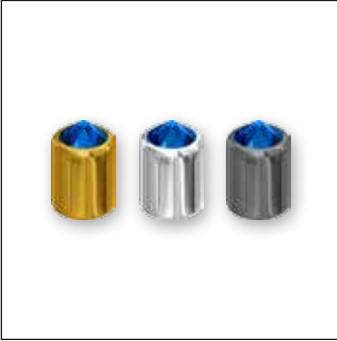

SS SS 16  
 M 1000 PCS **250%**

54 003 3D Studs 8 mm

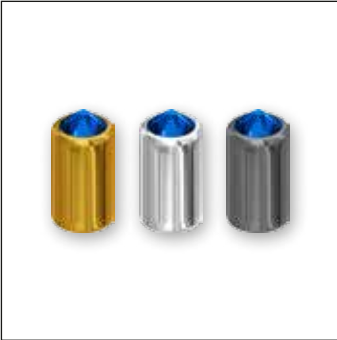

SS SS 16  
 M 500 PCS **250%**

54 001  
54 002  
54 003

**Color of Casing**

- 081 Gold
- 082 Silver
- 086 Gun Metal

**COLOR OF CRYSTALS**

**Colors**

**Plain Colors**

- Majestic Blue F [296] NEW!

# CRYSTAL MESH

---

## CRYSTAL MESH STANDARD – STAINLESS STEEL NEW

---

### Available Casing Colors

In addition to the new Stainless Steel casing, Crystal Mesh Standard is available with black, gold and silver colored casings.



012 Black



081 Gold



082 Silver



088 Stainless Steel **NEW**

40 000

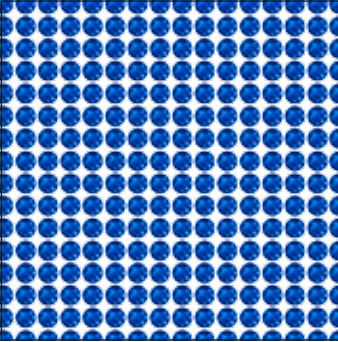

SH 100  
 S ~500x200  
 SS PP 21  
 M 1 SH 100%

40 001

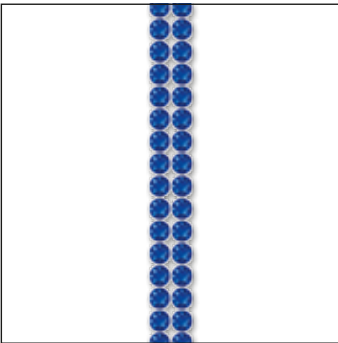

R 002-033  
 SS PP 21  
 M 10 M 100%

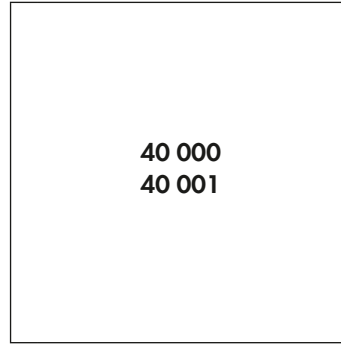

Color of Casing	012 Black	081 Gold	082 Silver	088 Stainless Steel
Crystal				
Colors				
Plain Colors				

**Crystal**

Crystal F (001)

**Colors**

**Plain Colors**

- Amethyst F (204)
- Aquamarine F (202)
- Black Diamond F (215)
- Blue Zircon F (229)
- Blush Rose F (257)
- Denim Blue F (266)
- Emerald F (205)
- Fern Green F (291)
- Fuchsia F (502)
- Graphite F (253)
- Greige F (284)
- Indian Pink F (289)
- Jet F (280)
- Jonquil F (213)
- Light Amethyst F (212)
- Light Colorado Topaz F (246)
- Light Rose F (223)
- Light Sapphire F (211)
- Light Siam F (227)
- Light Silk F (261)
- Light Turquoise F (263)
- Majestic Blue F (296) **NEW!**
- Padparadscha F (542)
- Peridot F (214)
- Provence Lavender F (283)

40 000 40 001		Color of Casing			
		012 Black	081 Gold	082 Silver	088 Stainless Steel
Rose F (209)		■	■	■	■
Rose Peach F (262)		■	■	■	■
Sapphire F (206)		■	■	■	■
Scarlet F (276)		■	■	■	■
Siam F (208)		■	■	■	■
Silk F (391)		■	■	■	■
Smoky Mauve F (265)		■	■	■	■
Smoked Topaz F (220)		■	■	■	■
Tangerine F (259)		■	■	■	■
Tanzanite F (539)		■	■	■	■
Topaz F (203)		■	■	■	■
Vintage Rose F (319)		■	■	■	■
Light Multi F (908) <sup>1</sup>		■	■	■	■
Rainbow Multi F (909) <sup>2</sup>		■	■	■	■
<b>Opal Colors</b>					
Rose Water Opal F (395)		■	■	■	■
Yellow Opal F (231)		■	■	■	■
<b>Crystal Effects</b>					
<b>Transparent Effects</b>					
Crystal AB F (001 AB)		■	■	■	■
Crystal Antique Pink F (001 ANTP)		■	■	■	■
Crystal Blue Shade F (001 BLSH)		■	■	■	■
Crystal Golden Shadow F (001 GSHA)		■	■	■	■
Crystal Lilac Shadow F (001 LISH)		■	■	■	■
Crystal Luminous Green F (001 LUMG)		■	■	■	■
Crystal Moonlight F (001 MOL)		■	■	■	■
Crystal Silver Night F (001 SINI)		■	■	■	■
Crystal Silver Shade F (001 SSHA)		■	■	■	■

40 000 40 001		Color of Casing			
		012 Black	081 Gold	082 Silver	088 Stainless Steel
<b>Metallic Effects</b>					
Crystal Dorado F (001 DOR)		■	■	■	■
Crystal Iridescent Green F (001 IRIG)		■	■	■	■
Crystal Light Chrome F (001 LTCH)		■	■	■	■
Crystal Metallic Blue F (001 METBL)		■	■	■	■
Crystal Metallic Light Gold F (001 MLGLD)		■	■	■	■
Crystal Metallic Sunshine F (001 METSH)		■	■	■	■
Crystal Rose Gold F (001 ROGL)		■	■	■	■
Crystal Scarabaeus Green*** F (001 SCGR)		■	■	■	■
<b>Crystal Lacquer<sup>PRO</sup></b>					
Crystal Powder Blue (001 L104)		■	■	■	■
Crystal Powder Green (001 L102)		■	■	■	■
Crystal Powder Rose (001 L103)		■	■	■	■
Crystal Powder Yellow (001 L101)		■	■	■	■
<b>Color Effects</b>					
<b>Transparent Effects</b>					
Black Diamond Shimmer F (215 971)		■	■	■	■
Erinite Shimmer F (360 971)		■	■	■	■
Light Colorado Topaz Shimmer F (246 971)		■	■	■	■
Light Sapphire Shimmer F (211 971)		■	■	■	■
Light Siam Shimmer F (227 971)		■	■	■	■
Light Topaz Shimmer F (226 971)		■	■	■	■
<b>Metallic Effects</b>					
Jet Hematite F (280 HEM)		■	■	■	■
Jet Nut F (280 NUT)		■	■	■	■

<sup>1</sup> Light Multi F consists of Crystal, Peridot, Light Amethyst, Jonquil, Aquamarine.

<sup>2</sup> Rainbow Multi F consists of Topaz, Light Siam, Fuchsia, Peridot, Sapphire.

\*\*\* designed by Jean Paul Gaultier



CRYSTAL FINE MESH

40 600

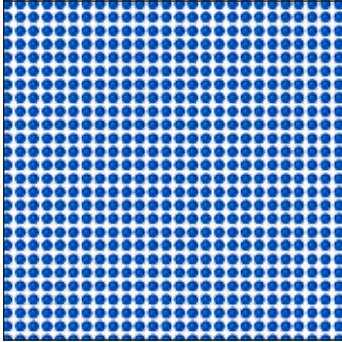

SH 100  
 S ~500x200  
 SS PP 9  
 M 1 SH 100%

40 601

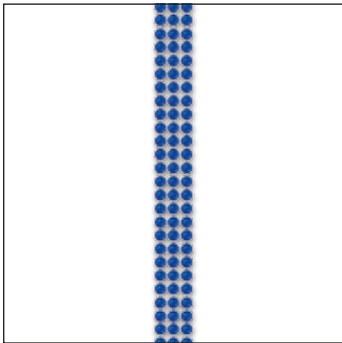

R 003-033  
 SS PP 9  
 M 10 M 100%

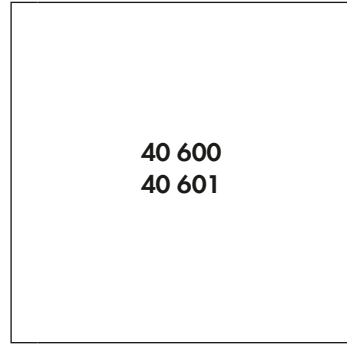

Colors

Plain Colors

● Majestic Blue F [296]

Color of Casing  
 081 Gold  
 082 Silver

NEW!

TREND FLAG FREEDOM

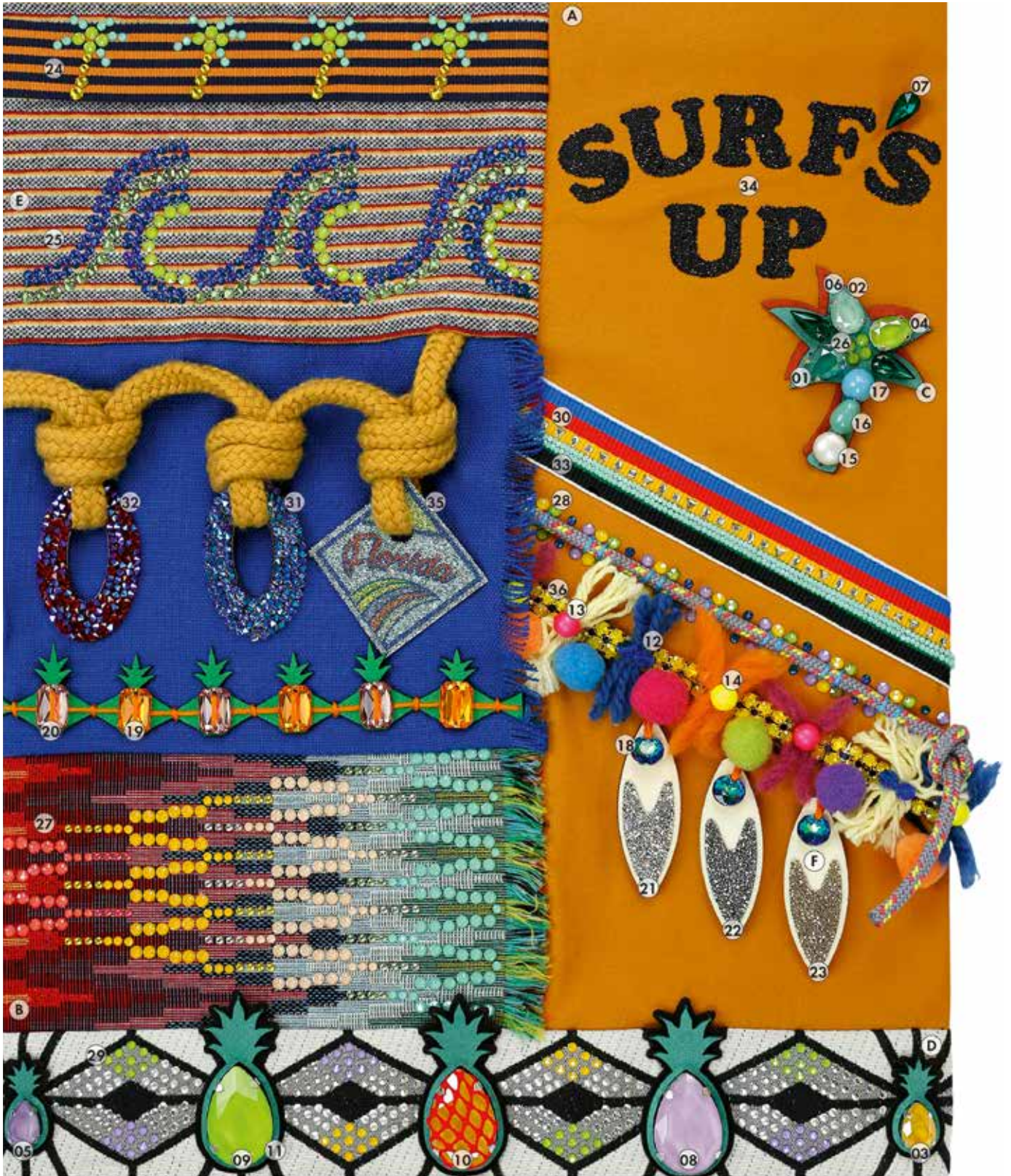

CRYSTAL INSPIRATION COLLECTION

## TREND FLAG FREEDOM

- 01 4320 14x10 mm 001 L109S
- 02 4320 14x10 mm 001 L115S
- 03 4320 14x10 mm 001 L124S **NEW**
- 04 4320 14x10 mm 001 L125S **NEW**
- 05 4320 14x10 mm 001 L126S **NEW**
- 06 4320/S 14x10 mm 3PH2OH
- 07 4322 14x7 mm 205 F
- 08 4327 30x20 mm 001 L124S **NEW**
- 09 4327 30x20 mm 001 L125S **NEW**
- 10 4327 30x20 mm 001 L126S **NEW**
- 11 4327/S 30x20 mm 3PH2OH
- 12 5000 6 mm 296 **NEW**
- 13 5810 8 mm 001 732
- 14 5810 8 mm 001 734
- 15 5810 10 mm 001 709
- 16 5821 11x8 mm 001 715
- 17 5860 10 mm 001 954 **NEW**
- 18 6430 10 mm 001 BBL P **NEW**
- 19 3252 14x10 mm 292 F **NEW**
- 20 3252 14x10 mm 319 F **NEW**
- 21 896785 Crystal Ultrafine Rocks IT Special Motif (I010 001CAL)
- 22 896785 Crystal Ultrafine Rocks IT Special Motif (I010 001CHRM)
- 23 896785 Crystal Ultrafine Rocks IT Special Motif (I010 001METS)
- 24 13355 001L115S/226/001L125S/226 **NEW**
- 25 596379 Transfer Special Motif (296/214/001L125S) **NEW**
- 26 596380 Transfer Special Motif (001L125S) **NEW**
- 27 596381 Transfer Special Motif (261/226/214/542/001L106S/001L124S/  
001L115S/001L116S/001L115S/001L106S/01L124S/001L116S) **NEW**
- 28 596383 Transfer Special Motif (296/001L126S/001L124S/001L125S) **NEW**
- 29 596384 Transfer Special Motif (092/082/001L126S/001L125S/001L124S) **NEW**
- 30 596938 Transfer Special Motif (001/001/001) **NEW**
- 31 349473 Crystal Rocks Special Motif (O12 001SHIM)
- 32 349473 Crystal Rocks Special Motif (O12 227SHIM)
- 33 710716 Crystal Fine Rocks Special Motif (O10 397)
- 34 615050 Crystal Fabric Special Motif (O12 280HEM)
- 35 57388 GP15034 022 001CAL
- 36 55000/002 022 081 231

## MATERIAL INFORMATION

- A Cotton
- B Handwoven Cotton
- C Alcantara®
- D Cotton Mix
- E Jersey Mix
- F Wood



SEGMENT FLAG BEACH WEAR

CRYSTAL INSPIRATION COLLECTION



## SEGMENT FLAG BEACH WEAR

- 01 1088 SS 39 001 L124S <sup>NEW</sup>
- 02 1088 SS 39 001 L125S <sup>NEW</sup>
- 03 1088/S SS 39 PH2OH
- 04 4470 10 mm 001 L115S
- 05 4470 10 mm 001 L126S <sup>NEW</sup>
- 06 4470 10 mm 001 L125S <sup>NEW</sup>
- 07 4470 10 mm 296 F <sup>NEW</sup>
- 08 4470 12 mm 001 L101
- 09 4470 12 mm 001 L125S <sup>NEW</sup>
- 10 4470/S 10 mm 3PH2OH
- 11 4470/S 12 mm 3PH2OH
- 12 5000 6 mm 296 <sup>NEW</sup>
- 13 5328 4 mm 296 AB <sup>NEW</sup>
- 14 5810 6 mm 001 954 <sup>NEW</sup>
- 15 5810 8 mm 001 945
- 16 5810 12 mm 001 945
- 17 5860 10 mm 001 954 <sup>NEW</sup>
- 18 6430 14 mm 001 AB <sup>NEW</sup>
- 19 6430 14 mm 203 <sup>NEW</sup>
- 20 3252 20x14 mm 296 F <sup>NEW</sup>
- 21 3252 28x20 mm 001 AB F <sup>NEW</sup>
- 22 13364 369SHIM/296/001L124S/001L126S/001L125S/001L110S <sup>NEW</sup>
- 23 597377 Transfer Special Motif (212/001L109S/001L116S/001L115S)
- 24 597378 Transfer Special Motif (001L126S/542/001L107S/001L106S) <sup>NEW</sup>
- 25 597379 Transfer Special Motif (296/296/001L116S/001L114S) <sup>NEW</sup>
- 26 597381 Transfer Special Motif (296/001L125S/539/001L126S) <sup>NEW</sup>
- 27 597383 Transfer Special Motif (296/001L112S/001L124S) <sup>NEW</sup>
- 28 597385 Transfer Special Motif (001L112S/001L108S/001L124S) <sup>NEW</sup>
- 29 597388 Transfer Special Motif (001L106S/215SHIM/001L126S) <sup>NEW</sup>
- 30 597389 Transfer Special Motif (539/539/001L126S/001AB/001/001AB) <sup>NEW</sup>
- 31 710777 Graphic Fine Rocks Special Motif (GP15068 022/001)

## MATERIAL INFORMATION

- A Technical Fabric
- B Linen
- C Alcantara®



TREND FLAG ADVENTURE

CRYSTAL INSPIRATION COLLECTION



## TREND FLAG ADVENTURE

- 01 **4228** 8x4 mm 296 F **NEW**  
 02 **4320** 14x10 mm 001 L126S **NEW**  
 03 **4320** 14x10 mm 296 F **NEW**  
 04 **4320/S** 14x10 mm 3PH2OH  
 05 **4470** 10 mm 296 F **NEW**  
 06 **4470/S** 10 mm 3PH2OH  
 07 **5000** 6 mm 296 **NEW**  
 08 **5328** 4 mm 296 **NEW**  
 09 **5810** 3 mm 001 954 **NEW**  
 10 **5810** 10 mm 001 954 **NEW**  
 11 **6228** 10,3x10 mm 296 **NEW**  
 12 **2078** SS34 001 L126S HFT **NEW**  
 13 **3252** 20x14 mm 253 F **NEW**  
 14 **3252** 20x14 mm 280 **NEW**  
 15 **13357** R8012/R6025/542/276/542/276/296 **NEW**  
 16 **13358** 296 **NEW**  
 17 **13359** 296/296/296/296 **NEW**  
 18 **596302** Transfer Special Motif (280GR)  
 19 **596303** Transfer Special Motif (234DORZ)  
 20 **596304** Transfer Special Motif (296) **NEW**  
 21 **596305** Transfer Special Motif (R9005/280)  
 22 **596306** Transfer Special Motif (091/001L124S/001L126S/001L126S/001L124S/001L126S/001L125S) **NEW**  
 23 **596308** Transfer Special Motif (296/296/296) **NEW**  
 24 **596942** Transfer Special Motif (280 GR/280HEM GM/001650 GR/215LTCHZ/212/215/001) **NEW**  
 25 **596943** Transfer Special Motif (001L126S/001SSHA/280/001SSHA/001SSHA/280) **NEW**  
 26 **53010** 086 001 ROGLV  
 27 **53700** 081 001  
 28 **53700** 086 280  
 29 **54002** 086 280 HEM  
 30 **54002** 086 280 HEM  
 31 **54003** 086 001 SSHA

## MATERIAL INFORMATION

- A Denim  
 B Woven Stripe  
 C Fake Leather  
 D Alcantara®  
 E Hessian



SEGMENT FLAG LEATHER

CRYSTAL INSPIRATION COLLECTION

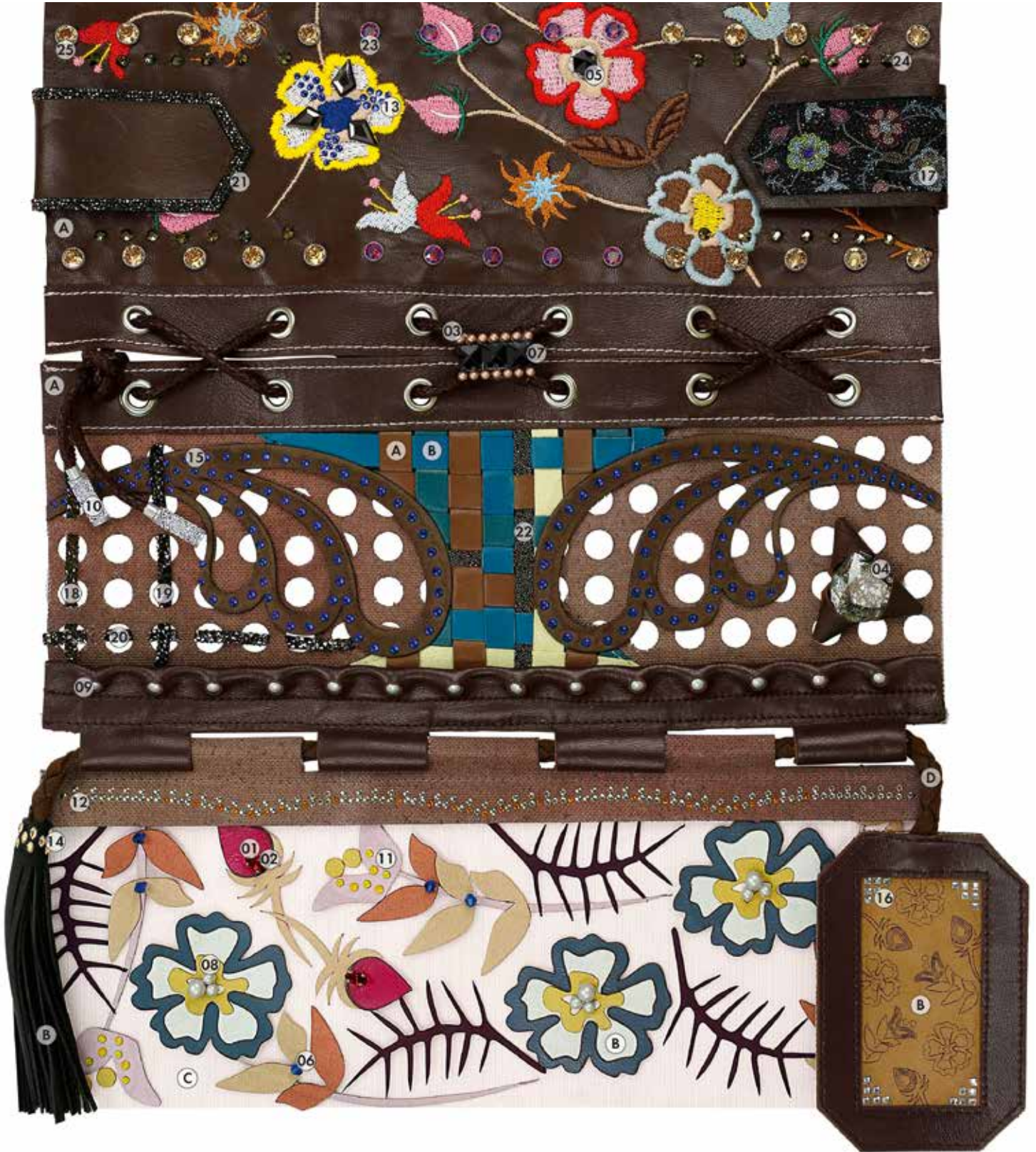

---

**SEGMENT FLAG LEATHER**

- ① **4228** 8x4 mm 276 F
- ② **4228/S** 8x4 mm 3PH2O3
- ③ **4418** 8 mm 280
- ④ **4706** 24 mm 001 BLAPA F
- ⑤ **5060** 7,5 mm 280 **NEW**
- ⑥ **5328** 4 mm 296 **NEW**
- ⑦ **5809** 3 mm 001 769
- ⑧ **5810** 4 mm 001 954 **NEW**
- ⑨ **5810** 6 mm 001 954 **NEW**
- ⑩ **5950** 15 mm 001MOL STEEL **NEW**
- ⑪ **13365** 231/001L124S **NEW**
- ⑫ **13366** 096/001METSH
- ⑬ **13367** 296/296/280HEM **NEW**
- ⑭ **598672** Transfer Special Motif (001GSHA) **NEW**
- ⑮ **597401** Transfer Special Motif (296/296/296) **NEW**
- ⑯ **597434** Transfer Special Motif (001) **NEW**
- ⑰ **615225** Graphic Fabric Print Special Motif (GP15072OP 012 280HEM)
- ⑱ **710778** Crystal Fine Rocks Special Motif (012 259)
- ⑲ **710778** Crystal Fine Rocks Special Motif (012 280NUT)
- ⑳ **710779** Crystal Fine Rocks Special Motif (012 001M109)
- ㉑ **896846** Crystal Ultrafine Rocks Special Motif (012 001REDM)
- ㉒ **615397** Crystal Fabric Special Motif (012 001COP)
- ㉓ **53001** 088 227SHIM
- ㉔ **53302** 088 001MLGLD
- ㉕ **53005** 088 001GSHA

## MATERIAL INFORMATION

- Ⓐ Lamb Nappa
- Ⓑ Alcantara®
- Ⓒ Tulle
- Ⓓ Cotton Canvas



TREND FLAG LEISURE

CRYSTAL INSPIRATION COLLECTION

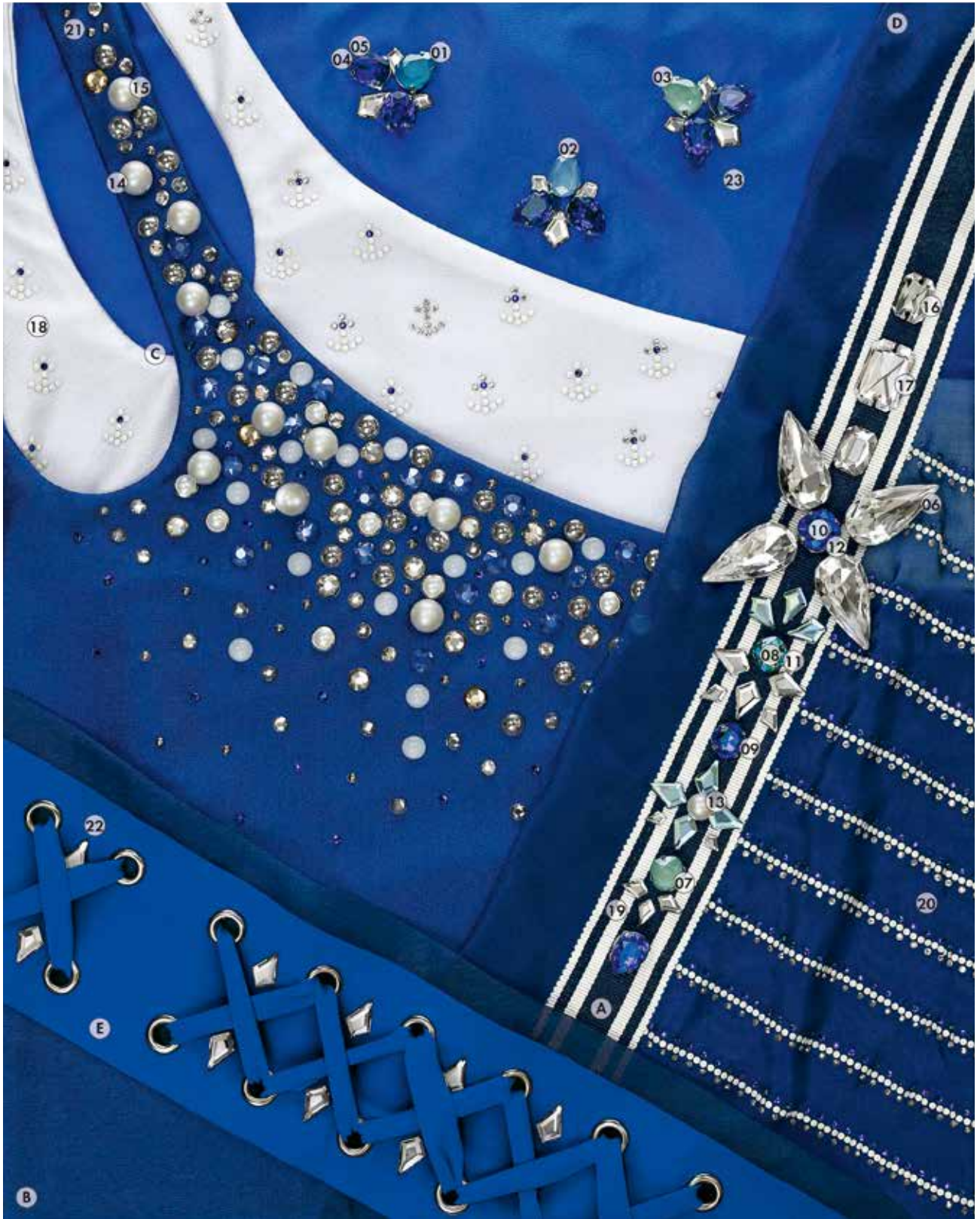



## TREND FLAG LEISURE

- 01 4320 14x10 mm 001 L112S
- 02 4320 14x10 mm 001 L114S
- 03 4320 14x10 mm 001 L115S
- 04 4320 14x10 mm 296 F <sup>NEW</sup>
- 05 4320/S 14x10 mm 3PH2OH
- 06 4322 30x15 mm 001 F <sup>NEW</sup>
- 07 4470 10 mm 001 L115S
- 08 4470 10 mm 360 971 F
- 09 4470 10 mm 296 F <sup>NEW</sup>
- 10 4470 12 mm 296 F <sup>NEW</sup>
- 11 4470/S 10 mm 3PH2OH
- 12 4470/S 12 mm 3PH2OH
- 13 5810 8 mm 001 954 <sup>NEW</sup>
- 14 5810 10 mm 001 954 <sup>NEW</sup>
- 15 5818 10 mm 001 954 <sup>NEW</sup>
- 16 3252 14x10 mm 001 F <sup>NEW</sup>
- 17 3252 20x14 mm 001 F <sup>NEW</sup>
- 18 13356 R9003/001/296 <sup>NEW</sup>
- 19 13360 001/001/001/202/001 <sup>NEW</sup>
- 20 596149 Transfer Special Motif (R9003/296/001/001LTCH) <sup>NEW</sup>
- 21 596150 Transfer Special Motif (001191SR/001LTCH/001LTCH/  
001L104/296/001LTCHZ/266LTCHZ/001L110S/001DORZ) <sup>NEW</sup>
- 22 596940 Transfer Special Motif (001) <sup>NEW</sup>
- 23 596941 Transfer Special Motif (001/001) <sup>NEW</sup>

## MATERIAL INFORMATION

- A Stripe Ribbon
- B Organza
- C Lycra
- D Silk
- E Jersey

SEGMENT FLAG DAY COCKTAIL WEAR



CRYSTAL INSPIRATION COLLECTION

## SEGMENT FLAG DAY COCKTAIL WEAR

- 01 1088 SS39 296 F **NEW**
- 02 1088/S SS39 3PH2OH
- 03 4161 15x5 mm 296 F **NEW**
- 04 4161/S 15x5 mm 1PH2OH
- 05 4320 14x10 mm 001 L114S
- 06 4320 14x10 mm 001 L115S
- 07 4320 14x10 mm 296 F **NEW**
- 08 4320/S 14x10 mm 3PH2OH
- 09 4322 14x7 mm 205 F **NEW**
- 10 4322 18x9 mm 001 F **NEW**
- 11 4470 10 mm 001 L114S
- 12 4470 10 mm 001 L115S
- 13 4470 12 mm 296 F **NEW**
- 14 4470/S 10 mm 3PH2OH
- 15 4470/S 12 mm 3PH2OH
- 16 6430 8 mm 001 **NEW**
- 17 6430 10 mm 001 **NEW**
- 18 5810 3 mm 001 954 **NEW**
- 19 5810 4 mm 001 954 **NEW**
- 20 5810 5 mm 001 954 **NEW**
- 21 5810 6 mm 001 954 **NEW**
- 22 3252 14x10 mm 001 F **NEW**
- 23 3252 14x10 mm 001SSHA F **NEW**
- 24 3252 14x10 mm 205 F **NEW**
- 25 3252 14x10 mm 296 F **NEW**
- 26 3252 20x14 mm 296 F **NEW**
- 27 13361 280DORZ/001DORZ/296 **NEW**
- 28 13362 R9003/001DORZ/001/001 **NEW**
- 29 13363 296/001/001/001 **NEW**
- 30 597238 Transfer Special Motif (001)
- 31 597239 Transfer Special Motif (202/001) **NEW**
- 32 710776 Crystal Fine Rocks Special Motif (010 001CAL)
- 33 89920 010 001CAL

## MATERIAL INFORMATION

- A Wash Silk
- B Douppion Silk



TREND FLAG CULTURE

CRYSTAL INSPIRATION COLLECTION





## TREND FLAG CULTURE

- 01 **4320** 14x10 mm 001 L124S **NEW**  
 02 **4320/S** 14x10 mm 3PH2OH  
 03 **4470** 10 mm 296 F **NEW**  
 04 **4470** 12 mm 296 F **NEW**  
 05 **4470/S** 10 mm 3PH2OH  
 06 **4470/S** 12 mm 3PH2OH  
 07 **5810** 5 mm 001 954 **NEW**  
 08 **5810** 8 mm 001 954 **NEW**  
 09 **3252** 14x10 mm 205 F **NEW**  
 10 **3252** 20x14 mm 001 F **NEW**  
 11 **3252** 28x20 mm 001 F **NEW**  
 12 **896800** Crystal Ultrafine Rocks IT Special Motif (010 I001AB)  
 13 **596760** Transfer Special Motif (R2003/R6032/R1018/001SSHA/296/227) **NEW**  
 14 **596761** Transfer Special Motif (R2003/R1018/R9003/001L124S/001LTCH)  
 15 **596763** Transfer Special Motif (R1018/R7045/369/001)  
 16 **596764** Transfer Special Motif (R7045/R1018/R5009/R9003/R6032/R3020/R7045/001)  
 17 **596765** Transfer Special Motif (R3020/R1018/R6032/369/231/227/205)  
 18 **596767** Transfer Special Motif (R3020/R3020/001L107S/001L116S/276)  
 19 **596769** Transfer Special Motif (R1018/R6018/R3020/R2003/R5021/1018/001L104/  
 001/001L112S/236/001L125S/279/231/001) **NEW**  
 20 **596776** Transfer Special Motif (R3020/R1018/001L125S/279/259/369/205) **NEW**  
 21 **596779** Transfer Special Motif (R1018/R6018/R2003/001L107S/001L125S/369/001) **NEW**  
 22 **710738** Crystal Fine Rocks Special Motif (010 227)  
 23 **615097** Crystal Fabric Special Motif (010 001AB)

## MATERIAL INFORMATION

- A Satin  
 B Acrylic Glass  
 C Cotton  
 D Lycra

SEGMENT FLAG JEWELRY

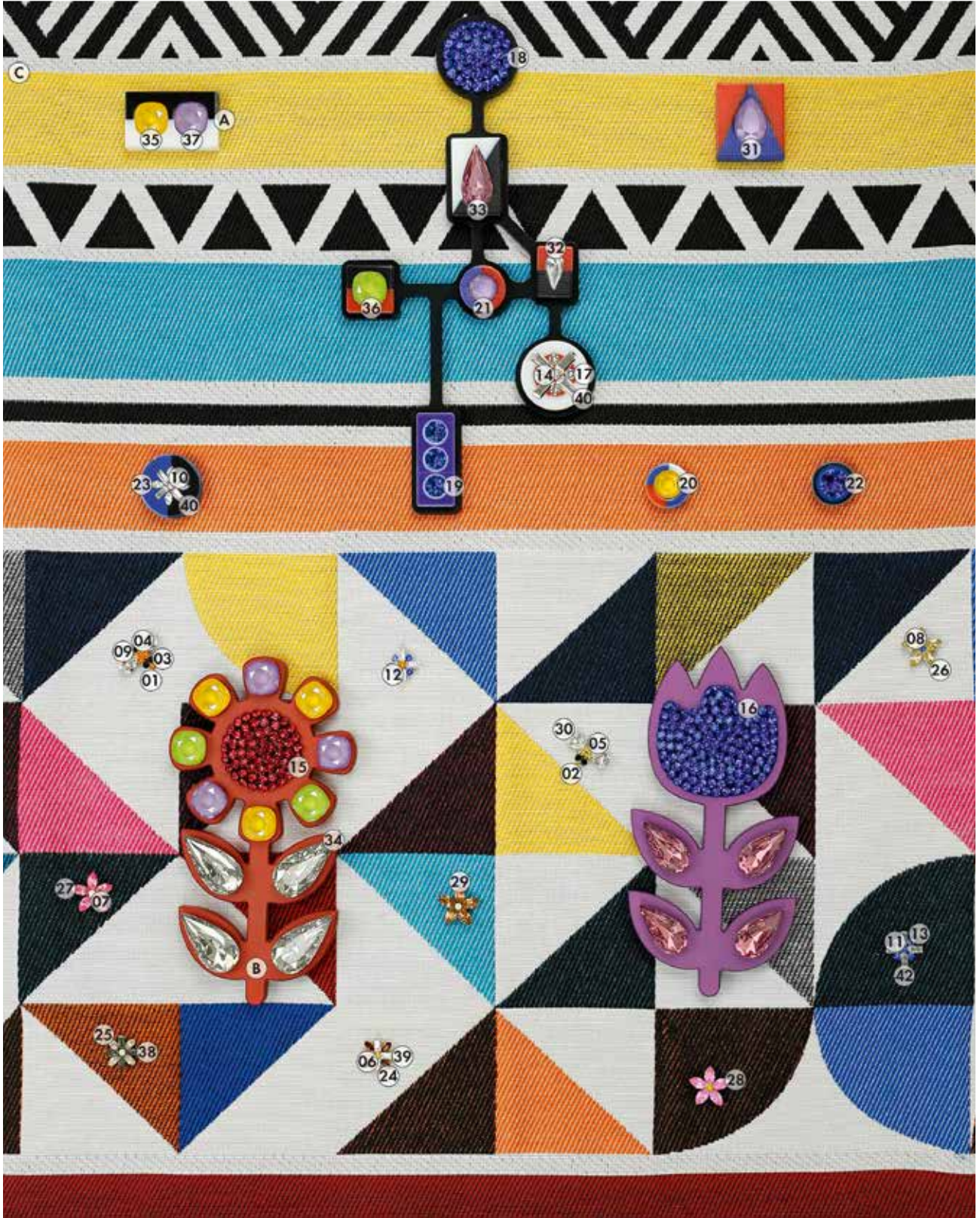

CRYSTAL INSPIRATION COLLECTION

## SEGMENT FLAG JEWELRY

- 01 1028 PP 9 203 F
- 02 1028 PP 9 231 F
- 03 1028 PP 9 280
- 04 1028 PP 13 203 F
- 05 1028 PP 13 226 F
- 06 1028 PP 13 231 F
- 07 1028 PP 13 234 F
- 08 1028 PP 13 243 F
- 09 1028 PP 13 280
- 10 1088 PP 14 001 F
- 11 1088 PP 14 243 F
- 12 1088 PP 18 231 F
- 13 1088 PP 18 243 F
- 14 1088 PP 21 001 F
- 15 1088 PP 21 276 F
- 16 1088 PP 21 296 F <sup>NEW</sup>
- 17 1088 PP 24 001 F
- 18 1088 PP 24 296 F <sup>NEW</sup>
- 19 1088 SS 29 296 F <sup>NEW</sup>
- 20 1088 SS 39 001 L124S <sup>NEW</sup>
- 21 1088 SS 39 001 L126S <sup>NEW</sup>
- 22 1088 SS 39 296 F <sup>NEW</sup>
- 23 4228 4x2 mm 001 F
- 24 4228 4x2 mm 220 F
- 25 4228 4x2 mm 261 F
- 26 4228 6x3 mm 001 LUMGR F
- 27 4228 6x3 mm 209 F
- 28 4228 6x3 mm 223 F
- 29 4228 6x3 mm 246 F
- 30 4320 6x4 mm 001 F
- 31 4320 14x10 mm 001 L126S <sup>NEW</sup>
- 32 4322 10x5 mm 001 F <sup>NEW</sup>
- 33 4322 18x9 mm 001 ANTP F <sup>NEW</sup>
- 34 4322 22x11 mm 001 SSHA F <sup>NEW</sup>
- 35 4470 10 mm 001 L124S <sup>NEW</sup>
- 36 4470 10 mm 001 L125S <sup>NEW</sup>
- 37 4470 10 mm 001 L126S <sup>NEW</sup>
- 38 4501 4x2 mm 215 F
- 39 4501 4x2 mm 001 F
- 40 4501 7x3 mm 001 F
- 41 4503 4x2 mm 001 F
- 42 4503 4x2 mm 001 F

## MATERIAL INFORMATION

- A 3D Print
- B Metal
- C Handwoven Cotton



# SWAROVSKI OFFICES & PARTNERS

## EUROPE

For Austria, Germany, Switzerland, Benelux, Scandinavia, UK, Ireland, France, Spain, Portugal, Greece, Africa and Eastern Europe, please contact SWAROVSKI INTERNATIONAL DISTRIBUTION AG Triesen:

### SWAROVSKI INTERNATIONAL DISTRIBUTION AG

Dröschstrasse 15  
Postfach 567  
9495 Triesen  
Liechtenstein  
Phone: +423 399 5757  
Fax: +423 399 5750  
sp.infoli@swarovski.com

### SWAROVSKI INTERNAZIONALE

D'ITALIA S.P.A.  
SOCIETA' A SOCIO UNICO  
Via Giorgio Giulini n.3  
20123 Milano  
Italy  
Phone: +39 02 722601  
sp.ii@swarovski.com

### SWAROVSKI OOO

BC "Sadovaya Plaza"  
Dolgorukovskaya str., h.7, floor 12  
127006 Moscow  
Russia  
Phone: +7 495 258 83 03  
sp.infoli@swarovski.com

### SWAROVSKI KRISTAL TIC.LTD.STI.

Abdi İpekçi Cad. Reasürans Han E Blok,  
No:57 Kat:5  
34367 Nişantaşı Şişli, İstanbul  
Turkey  
Phone: +90 (0) 212 225 44 29  
Fax: +90 (0) 212 225 27 99  
sp.infoli@swarovski.com

## MIDDLE EAST

### SWAROVSKI MIDDLE EAST FZE

P.O. Box 17128, Jebel Ali Free Zone  
Dubai  
United Arab Emirates  
Phone +971 4 8032047  
Fax: +971 4 881 5623  
farah.zaroug@swarovski.com  
palak.bhati@swarovski.com

### SWAROVSKI INDIA PVT. LTD.

1st Floor, Building 10C  
DLF Cyber City  
DLF Phase 2  
Gurgaon - 122002  
India  
Phone: +91 (124) 469 8200  
Fax: +91 (124) 469 8277  
customer\_service.in@swarovski.com

## NORTH & SOUTH AMERICA

### SWAROVSKI CRYSTAL COMPONENTS LTDA.

Alameda Itu, 852 - 13º Andar  
01421-001 São Paulo - SP  
Brazil  
Phone: +55 11 3088 8821 (ext. 121)  
Fax: +55 11 3088 5976  
comercial.br@swarovski.com

### SWAROVSKI NORTH AMERICA LTD.

1 Kenney Drive, Cranston  
Rhode Island 02920-4400  
USA  
Phone: +1 401 463 5132  
Fax: +1 401 463 4707  
Toll free: 1 800 463 0849  
sp.sna@swarovski.com

### SWAROVSKI NORTH AMERICA LTD.

Los Angeles Showroom,  
California Mart  
110 E. 9th Street, Suite B771  
Los Angeles, CA 90079-2827  
USA  
Phone: +1 213 489 2393  
Fax: +1 213 489 1961

### SWAROVSKI CRYSTAL S.A. DE C.V., MEXICO

Av. Ejército Nacional No. 579  
Piso 11, Local A  
Col. Granada  
Del. Miguel Hidalgo  
C.P. 11520  
México D.F.  
Phone: +5255 5000 0641

## ASIA

### SWAROVSKI HONG KONG LTD.

9th Floor, Fortis Centre,  
1063 King's Road  
Quarry Bay  
Hong Kong  
Phone: +852 2566 6301  
Fax: +852 2807 1902  
sp.infohk@swarovski.com

### SWAROVSKI (GUANGZHOU) TRADING COMPANY LTD.

Room 02-07, 17F, Central Tower  
No. 5, Xiancun Road,  
Zhujiang New Town,  
Tianhe District, Guangzhou 510623  
China  
Phone: +86 20 3813 2188  
Fax: +86 20 3810 2278  
Toll Free: +86 400 880 1744  
sp.infocn@swarovski.com

### SWAROVSKI (GUANGZHOU) TRADING COMPANY LTD.

Beijing Liaison Office  
Room 2001-2002,  
20/F, Tower B, Gemdale Plaza,  
No. 91, Jianguo Road,  
Chaoyang District,  
Beijing 100020  
China  
Phone: 010-65829773

### SWAROVSKI (GUANGZHOU) TRADING COMPANY LTD.

Shanghai Liaison Office  
Room 1602, The Headquarters Building  
No. 168, Xi Zang Road (M)  
Shanghai 200001  
China  
Phone: +86 21 2306 9945  
Fax: +86 21 6372 9180

### SWAROVSKI (GUANGZHOU) TRADING COMPANY LTD.

Qingdao Liaison Office  
Art & Technology Space Room  
No 1-506  
No. 63, Haier Road  
Qingdao 266061  
China  
Phone: +86 532 8099 9595  
Fax: +86 532 8099 9596

### SWAROVSKI (GUANGZHOU) TRADING COMPANY LTD.

Yiwu Liaison Office  
Room 8911, Xinguang International  
Business Building  
No. 1399, Chouzhou Road(North),  
Yiwu City, 322000  
Zhejiang Province  
China  
Phone: +86 579 8559 0903  
Fax: +86 579 8559 0707

### SWAROVSKI (GUANGZHOU) TRADING COMPANY LTD.

Shenzhen Liaison Office  
Room 13G, Tower C, NEO Building,  
6009 Shennan Avenue, Futian District  
ShenZhen 518048  
China  
Phone: +86 755 23605750  
Fax: +86 755 23605735

### SWAROVSKI TAIWAN LIMITED TAIWAN BRANCH

3/F, No. 27, Chung-Shan North Road  
Section 1, Taipei 104  
Taiwan, R.O.C.  
Phone: +886 2 2100 2611  
Fax: +886 2 2100 2622  
sp.infotw@swarovski.com

### SWAROVSKI SINGAPORE TRADING PTE. LTD.

2, Alexandra Road  
#03-01, Delta House  
Singapore 159919  
Singapore  
Phone: +65 6661 6333  
Fax: +65 6274 8177  
sp.infosg@swarovski.com

### PT CRYSTALLIZED ELEMENTS

Cyber 2 Tower, 31st Floor Unit B  
Jl. HR. Rasuna Said, Blok X5 No. 13  
Jakarta 12950  
Indonesia  
Phone: +62 21 2902 1451 / 52 / 53  
Fax: +62 21 2902 1454  
ptcrystallized.id@swarovski.com

### SWAROVSKI SINGAPORE PTE. LTD.

(Vietnam Representative Office)  
Level 16 & 17, CJ Tower  
6, Le Thanh Ton Street,  
Ward Ben Nghe, District 1  
Ho Chi Minh City, Vietnam  
Phone: +84 8 62556768  
Fax: +84 8 62556801  
jessica.ha@swarovski.com

### SWAROVSKI (THAILAND) LTD.

849 Varawat Building, 16th Floor,  
Room 1601 - 1602,  
Silom Road, Silom, Bangrak, Bangkok  
10500 Thailand  
Phone: +662 635 1990  
Fax: +662 635 1585  
sthspmarketing@swarovski.com

### SWAROVSKI KOREA LTD.

BaekYoung Building 13F(SP)  
(6 Cheongdam-dong) 456 Dosan-daero,  
Gangnam-gu, Seoul 06062,  
Korea  
Phone: +82 2 6930 9974  
Fax: +82 2 3416 0336  
jaylin.choi@swarovski.com

### SWAROVSKI JAPAN LTD.

Ichibancho Tokyu Building 12F,  
21 Ichiban-cho, Chiyoda-ku,  
Tokyo, 102-0082  
Japan  
Phone: +81 3 3262 3012  
Fax: +81 3 3262 3723  
sp.infojP@swarovski.com



## NEW ZEALAND

## SWAROVSKI INTERNATIONAL (NZ) LTD.

Shop 3, 45 Queen St  
Auckland 1010  
New Zealand  
Phone: +61 2 8345 7200  
Fax: +61 2 9313 6506  
elementsenquiries.sau@swarovski.com

## AUSTRALIA

## SWAROVSKI INTERNATIONAL (AUSTRALIA) PTY. LTD.

1/4D Huntley St  
Alexandria NSW 2015  
Australia  
Phone: +61 2 8345 7200  
Fax: +61 2 9313 6506  
elementsenquiries.sau@swarovski.com

## SWAROVSKI COMMUNICATION &amp; CREATIVE SERVICE CENTERS WORLDWIDE

## LONDON

## CORPORATE BRANDING &amp; COMMUNICATION

## SWAROVSKI CRYSTAL BUSINESS

21 Sackville Street  
London, W1S 3DN, 2nd Floor  
United Kingdom  
Phone: +44 (0) 20 7255 8400  
Fax: +44 (0) 20 7255 8473  
www.swarovski.tv  
www.swarovskigroup.com  
www.atelierswarovski.com  
www.swarovskicrystalpalace.com

## LOS ANGELES

## SWAROVSKI NORTH AMERICA LTD.

Los Angeles Showroom,  
California Mart  
110 E. 9th Street, Suite B771  
Los Angeles, CA 90079-2827  
USA  
Phone: +1 213 489 2393  
Fax: +1 213 489 1961

## SWAROVSKI CORPORATE COMMUNICATIONS UNIT &amp; CREATIVE SERVICES CENTER

8560 W. Sunset Blvd., Suite 200  
West Hollywood, CA 90069  
Los Angeles  
Phone: 310-652-0089 x3813  
Fax: 310-652-0951

## DUBAI

## SWAROVSKI MIDDLE EAST FZE

P. O. Box 17128, Jebel Ali Free Zone  
Dubai  
United Arab Emirates  
Phone: +971 4 881 6562  
Fax: +971 4 881 5623  
farah.zaroug@swarovski.com  
palak.bhati@swarovski.com

## SINGAPORE

## CORPORATE BRANDING &amp; COMMUNICATION &amp; ATELIER SWAROVSKI ASIA PACIFIC

## SWAROVSKI MANAGEMENT PTE LTD

2 Alexandra Road  
#03-02 Delta House  
Singapore 159919  
Singapore  
Tel.: +65 6661 6333  
atelierapac@swarovski.com

## MILAN

## SWAROVSKI INTERNAZIONALE D'ITALIA S.P.A.

SOCIETA' A SOCIO UNICO  
Via Giorgio Giulini n.3  
20123 Milano  
Italy  
Phone: +39 02 722601  
stefania.fedeli@swarovski.com

## NEW YORK

## SWAROVSKI CREATIVE SERVICE CENTER

10 E 53rd Street, 26th Floor  
New York, NY 10022  
USA  
Phone: +1 212 935 4200  
Fax: +1 212 935 8800  
Toll free: 1 877 888 7980

## PARIS

## SWAROVSKI FRANCE S.A.S.

15, Boulevard Poissonnière  
75002 Paris  
France  
Phone: +33 1 4476 1515  
sp.france@swarovski.com

## CORPORATE BRANDING &amp; COMMUNICATIONS PARIS

374 rue saint Honoré  
75001 Paris  
France  
Phone: +33 (0) 1 42 56 29 84  
Fax: +33 (0) 1 45 61 17 67  
Nadine.mao@swarovski.com

## SÃO PAULO

## SWAROVSKI CRYSTAL COMPONENTS LTDA.

Alameda Itu, 852 - 13º Andar  
01421-001 São Paulo - SP  
Brazil  
Phone: +55 11 3088 8821  
Fax: +55 11 3088 5976  
comercial.br@swarovski.com

## WATTENS

## D. SWAROVSKI KG

Lindenstraße 1  
6112 Wattens  
Austria  
Phone: +43 5224 500 3307  
Fax: +43 5224 501 3307  
sandra.oconnor@swarovski.com

## SWAROVSKI TREND &amp; APPLICATION CENTERS WORLDWIDE

## HONG KONG

Fortis Centre, 1063 King's Road,  
9th Floor  
Quarry Bay, Hong Kong  
Hong Kong  
Phone: +852 2566 6301  
Fax: +852 2807 1902

## BEIJING

Rm 2001-2002, 20 F, Tower B,  
Gemdale Plaza, No. 91,  
Jianguo Road, Chaoyang District  
Beijing 100020  
China  
Tel: 010-65829773

## SHANGHAI

The Headquarters Building  
No. 168, Xi Zang Road (M),  
Room 1602  
Shanghai 200001  
China  
Phone: +86 21 2306 9945  
Fax: +86 21 6372 9180

## GUANGZHOU

Room 02-07, 17F, Central Tower  
No. 5, Xiancun Road,  
Zhujiang New Town,  
Tianhe District, Guangzhou 510623  
China  
Phone: +86 20 3813 2188  
Fax: +86 20 3810 2278  
Toll Free: +86 400 880 1744

## BANGKOK

## SWAROVSKI (THAILAND) LTD.

849 Vorawat Building, 16th Floor,  
Room 1601 - 1602,  
Silom Road, Silom, Bangrak, Bangkok  
10500  
Thailand  
Phone: +662 635 1990  
Fax: +662 635 1585  
sirikarn.ngamboonsin@swarovski.com

## TOKYO JAPAN TAC

## SWAROVSKI JAPAN LTD.

Ichibancho Tokyu Building 12F,  
21 Ichiban-cho, Chiyoda-ku,  
Tokyo, 102-0082  
Japan  
Phone: +81 3 3262 3012  
Fax: +81 3 3262 3723  
sp.infoJP@swarovski.com

---

## GENERAL WARNING

Loose crystals may present a small parts hazard to young children, particularly children under three years old. Depending on the size of the crystal and any attached material (such as glue, fabric, etc.), children may choke on, inhale, swallow, or insert the crystal into their noses. Magnetic products with crystal applications pose a particular risk of serious intestinal injury if ingested. The application techniques as stated in the Application Manual do not guarantee that crystals will not come loose. For each application, the manufacturer must determine whether the product meets the relevant requirements related to small parts hazards and assess any risk it may pose to small children. Failure to follow Swarovski's care instructions may result in damage to the crystal, which could pose a risk of laceration or other harm.

### **Warning for Tableware**

Application of loose crystals to tableware presents a potential risk of aspiration, choking, swallowing, or tooth damage should crystals become loose. To reduce this risk, crystals should never be applied to any surface of tableware likely to come in contact with food or the mouth, and crystals should never be placed on any tableware intended for use by children. Tableware with crystals intended for decorative use only should be marked as such. To avoid dishwasher damage, tableware decorated with crystals should be washed by hand. The application techniques or suggestions in this manual do not guarantee that crystals will not come loose. For each application, the manufacturer must determine whether the product meets relevant requirements related to small parts hazards or use in food contact items and assess any risk it may pose to users.

The use of crystals (which may contain restricted substances deemed hazardous under local laws) and adhesives on tableware is subject to legal restrictions in specific countries. The customer is fully responsible to comply with these country-specific provisions and shall defend, indemnify, and hold Swarovski harmless from any and all third-party claims based on product liability or otherwise relating to uses of Swarovski products and waives all its own claims against Swarovski.

### **Notice for Application on Packaging**

The use of crystal that may contain substances like lead, cadmium or hexavalent chromium, on packaging is subject to legal restrictions in specific countries, including but not limited in regard to the total content of substances based on the proportion between crystal mass to the remaining weight of packaging. The customer is fully responsible to comply with these country-specific provisions and to pass on this information to his customers.

### **Care Instructions**

Failure to follow Swarovski's care instruction may result in damage to the Swarovski product, which could pose a risk of laceration or other harm.

Please be informed that all conventional laundering processes (household washing machine as well as professional dry-cleaning)

have a considerable mechanical influence onto the garment, which is based on the rotation of the washing drum. The essential requirement for a safety laundering process is that the Swarovski products are proper applied without restrictions regarding the adherence of the Swarovski products. The bigger the size of the used Swarovski product is and the more Swarovski products are applied next to each other, the more a risk of damage has to be taken into consideration. Swarovski products are made of or incorporate crystal and therefore must be handled with due care! Generally, to best protect the Swarovski products from breaking we recommend the use of a soft washing bag and to fill up the washing drum. Turning inside out before washing and selection of a gentle washing program, plus the use of mild detergents are important prerequisites to safeguard the quality of our Swarovski products. Our care instructions based on DIN EN ISO 3758 list up all Swarovski product groups as overview so that each used Swarovski product still needs to be judged in terms of its cleaning suitability for the intended purpose and finished product by the customer. Swarovski's recommendations are given according to the current state of our knowledge and Swarovski's determination of the qualification as textile application product. The customer is therefore fully responsible to determine the cleaning process applicable to the finished product, taking the Swarovski care instructions as well as those of third party materials into account. The variety of shape, cut, surface effect, size and application weight respectively amount of used Swarovski products are decisive for the determination of the suitable cleaning process. To be entirely safe customers respectively dry-cleaners usually take off Sew-on Stones, Buttons, etc. of bigger size before cleaning and re-apply them afterwards.

### **Unsuitable Applications**

Crystals from Swarovski are intended for use in the fields of fashion, jewelry, accessories, textile products, and for interior décor. Due to their physical properties, crystals from Swarovski are unsuitable for other uses (e.g. gluing onto teeth, using crystals on or near mucous membranes, and other unsafe uses). The customer shall defend, indemnify and hold Swarovski harmless from any and all third-party claims based on product liability or otherwise relating to uses of Swarovski products purchased by the customer, and waives all its own claims.

### **Responsibility of User**

Any oral, written, or test-based advice that Swarovski provides regarding techniques for application of its products are recommendations based on Swarovski's current knowledge and the information provided by its suppliers. Such advice does not discharge the customer from carrying out its own tests of techniques it proposes to use and their suitability for the intended application. The application, use, and processing of these techniques and products are solely the user's responsibility.

---

**CREDITS**

## CULTURE

La Double J Vintage selection

Miumiu

Alcoolique

Giuseppe di Morabito

## SVEVA COLLECTION

Swarovski Corporate Archive:

Earrings, Atelier Marangoni, Italy, 1960s

Ornaments, Designer unknown, 2000s

Earring, Atelier Marangoni, Italy, 1970s

## FREEDOM

## GCDS

Los Trapitos Al Sol

## SVEVA COLLECTION

Swarovski Corporate Archive:

Earrings, Atelier Marangoni, Italy, 1970s

## ADVENTURE

Giuseppe di Morabito

La Double J

La Jolie Fille

Casadei

SCHIELD by Roberto Ferlito

[www.stilsparkle.etsy.com](http://www.stilsparkle.etsy.com)

Swarovski Corporate Archive:

Bracelet, Atelier Marangoni, Italy, 1980s/2000s

Buckles, Atelier Marangoni, Italy, 1960s/1990s

Bracelets, Swarovski for Dolce & Gabbana, Italy, 2000s

Earrings, Swarovski for Dolce & Gabbana, Italy, 2000s

## LEISURE

La Reveche

Oseree

Ca&Lou

viola Cora

SCHIELD by Roberto Ferlito

Swarovski Corporate Archive:

Earring, Atelier Marangoni, Italy, 1960s

—  
Content by Swarovski Professional Headquarters, Wattens

Creative Direction: Giovanna Battaglia Engelbert

Stylist: Enrica Ponzellini

Brochure design: in the headroom

Fashion Photography: Kiki Xue, Carolina Mizrahi

Printed by RWF Frömel-Hechenleitner Werbeges. m. b. H.

VALID FROM FEBRUARY 2018

Sys.No. 5429656

Content is subject to change without notice.

Errors and misprints excepted.

Please note, the actual products may deviate from the pictures in color and effect.

D. Swarovski Distribution GmbH, Swarovskistrasse 30, 6112 Wattens, Austria

© 2018 D. Swarovski Distribution GmbH. All rights reserved. Partial or total publication, transmission, copy or other duplication of texts, graphics, pictures etc. which are to be found in this publication is forbidden without special consent by D. Swarovski Distribution GmbH.

Swarovski® is a registered trademark of Swarovski AG.

Please visit our website for contact information: SWAROVSKI-PROFESSIONAL.COM



\*Swarovski Professional is a certified member of RJC

